



LIFE FLOOR

lookbook 2020

Rewarding Risky Play

A message from Life Floor CEO Jonathan Keller

2019 has been, without a doubt, a landmark year in the history of our company.

With the creation of **NSF/ANSI 50's new standard for interactive water play venues** this summer, we're celebrating that Life Floor is more than just a safety surface. All over the world, more and more people are choosing Life Floor because it means their customers, guests, and communities can play more in water when they're playing on Life Floor.

In 2016, I had the honor of presenting our white paper, "**Splash Pads Need Safety Surfaces,**" to the NSF/ANSI 50 joint committee on aquatic recreation, which proposed that NSF could create a rigorous, performance-based standard for splash pad surfaces. Throughout the process, we were struck again and again by the professionalism and incredible expertise present in our industry, as so many partners across the world offered advice and insight into the fledgling standard. To learn more about the results, check out **page 6** of this lookbook or visit our webpage at lifefloor.com/NSF50 to find out more about what this standard will mean for you and your facility.

In creating the new safety standard, we also learned a great deal about our colleagues in splash pad feature manufacturing. More than anything, we learned that "**risky play**" was at the heart of so many splash pad designs, the theory that play that encourages risk-taking is invaluable for childhood development. Wouldn't applying safety surfacing to a splash pad just be "bubble wrapping" kids? (Someone actually said this to me!)

The truth is, the point of splash pads has never been to interact with a risky surface. We're based in Minnesota, so we're pretty familiar with the recreational area that's supposed to have a risky surface. It's called an **ice skating rink**. A splash pad, on the other hand, is intended for play in spraying, splashing, and dumping water. **With this in mind, Life Floor actually enables kids to do more in water, including risky play.** Concrete and other conventionally-surfaced splash pads have always put restrictions on play. Running, jumping, rolling—these activities could be dangerous, or at least very uncomfortable, on a hard, abrasive floor. On Life Floor splash pads, we've seen kids run, jump, roll, wrestle, tumble, do handstands, all while playing in water. Safety surfacing encourages kids to spend more time on splash pads, exploring, connecting, and playing just the way they want to.

The goal of splash pad play is to have fun, experiment, and take risks by moving in water and interacting with water and water features. Surfacing should be serving this goal. All over the world, word is catching on, from sunny Australia, back home to Minnesota, where the weather is already getting cooler, and we're already hitting the ice. We love risky play, but we love risky play on Life Floor even more.

On behalf of the Life Floor team,

Jonathan Keller



The Keller Family on the ice in Minneapolis, Minnesota.

What's inside our

2020 Lookbook?

What's New?

- 6 NSF 50 Announcement
- 8 Perfect Day at CocoCay
- 12 Australia Zoo
- 16 Sugarworld
- 20 Westfield Memorial Pool
- 24 Vidanta Riviera Maya

Studio

- 30 Color Options
- 32 Themes
- 38 Hexagons/Rectangles
- 40 Squares
- 42 Triangles
- 44 Inlaid Designs
- 46 Fun Spot: America
- 48 Patterns
- 50 Ripple
- 52 Slate
- 54 Depth Markers
- 56 Slide Pads
- 58 Transition Strips
- 60 Drain Cover
Coping and Wraps

Featured Applications

- 64 Atlantis the Palm
- 68 Splash Pads
- 70 LEGOLAND®
- 72 The Beach
- 74 Indoor Pool Decks
- 82 Outdoor Pool Decks
- 84 Under Multi-level Play Structures
- 88 On Multi-level Play Structures
- 90 Zero Depth Entries
- 92 Edge Pads and Slide Towers
- 94 Cruise Ship Water Parks
- 96 InsideEdge Announcement
- 98 Technical Data

Life Floor is a foam-rubber aquatic safety surface designed for use in wet areas with barefoot traffic. Created as an alternative to concrete and other conventional materials, *Life Floor* is the only safety surface specifically designed and engineered to perform in aquatic environments.

Why do people love to walk* on *Life Floor*?

Life Floor combines award-winning safety with unparalleled design capabilities, delivered by an expert team committed to a world-class experience for everyone who interacts with our products.

All over the world, people trust *Life Floor* to make their aquatic environments look and feel extraordinary.

*While on *Life Floor*, people also love to run, jump, roll, somersault, dance, dip, cha-cha, skip, saunter, sashay, wiggle, twist, twirl, whirl, or even do a handstand or two.



SPLASH
PADS =
PLAYGROUNDS
+ WATER



Life Floor is now the first and only safety surface certified to **NSF/ANSI Standard 50: Interactive Water Play Venues**

The Next Revolution in Aquatics is here. **Life Floor** is Leading the Way.

In 2019, after four years of research, testing, and careful deliberation, **NSF/ANSI 50** has created a new standard for splash pad surfaces, recommending that all splash pads now include a surface that is both cushioned and slip-resistant with the ability to perform in the aquatic environment.

This standard was created with the knowledge that playgrounds and splash pads are used in remarkably similar ways. **Splash pads are simply playgrounds + water.** As a result, they share some similar safety concerns. Most importantly, splash

pad injuries could be mitigated or prevented by using a safety surface—namely, a surface that is both cushioned and slip-resistant without being abrasive.

Life Floor is the first surface in the world to meet this new standard, and we're proud to contribute to the process of creating these new safety requirements. Life Floor is here to help you understand what the new standard means for your facility or for your clients. **Visit lifefloor.com/NSF50 to watch our intro video and more.**

Play More At

Perfect Day Coco Cay

Royal Caribbean's Perfect Day at Coco Cay is a dream destination for cruisers, a private island packed with things to do, see and experience against the backdrop of the balmy natural beauty of the Bahamas.



PERFECT DAY

Families relax on white sand beaches, or take on the challenge of the tallest waterslide in North America. For the youngest vacationers, **Splashaway Bay** is something truly special, stocked with splash and spray features and crowned with a play structure by **Vortex**.

With a design by **Martin Aquatics**, Life Floor brings the bright colors of the features, slides, and play structure to the play surface, so kids can run from starfish to starfish, or jump between gumdrops. Life Floor lets kids play actively and enjoy the day playing freely, safely, and imaginatively.

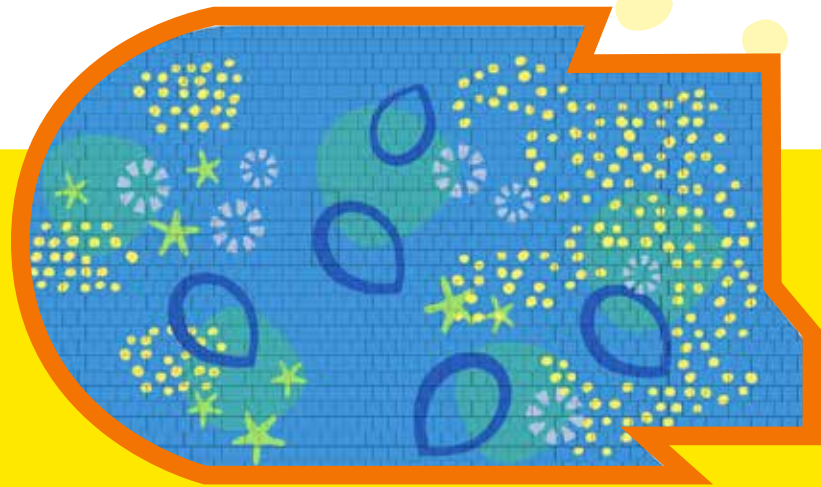

Coco Cay

Facility: Coco Cay

Location: Little Stirrup Cay, The Bahamas

Install Date: May 2019

Installer: Inside Edge

Designers: Martin Aquatic

Square footage: 5,656 sq ft

Tile: Ripple 2.0

Colors: Aviator, Iceberg, Limelight, Ocean, Sunshine, and Turquoise



Discover More At



*Home of The
Crocodile Hunter*

While many zoos strive to present their attractions through scientific objectivity, **Australia Zoo** takes a different approach. Yes, science is important, even paramount, but there's no attempt at objectivity.

The people at Australia Zoo absolutely love animals, and they want you to love them, too.



In reality, you're experiencing the animals and their habitats through a personal lens, the infectious enthusiasm of the great Steve Irwin and his family. Animals are named, you can pet kangaroos, you can even cuddle with a koala. Where many zoos seem designed around separation and observation from a distance, the animal enclosures at Australia Zoo are open and sprawling. The point is to forge a personal connection to the animals as individuals, to develop the passion Steve Irwin was known for, and experience the environment not only with your eyes, but with your body and your heart.

For this reason, it's no surprise that Australia Zoo has created a beautiful splash pad at the center of their Laughing Lolly Shop and Water Park, a place where kids can not only play and cool off in the blazing Queensland sun, but also to explore beautiful sculptures of Australian animals, designed by the Zoo's artist team.

True to their environmental mission, they use water recycling components to reduce waste. But the splash pad needed the final touch of a surface that would keep their littlest guests safe, active, and fully immersed in the fun of nature and water.

"The floor added some bright, attractive colours which have certainly added to the fun and excitement. It allowed us to be flexible and creative in our design and planning which created a wonderful finished product. Life Floor has given us a soft, non-slip surface which has received fantastic feedback from our guests. The installation has made it far more enjoyable for little people, rather than the more common, abrasive surfaces that are used," said Darren Gertler, Director of Marketing for the Australia Zoo about why they chose Life Floor for this world-class feature.

"The safety and comfort of our guests is paramount, so when choosing a surface one of our priorities was something safe and knee-friendly. Many hours were spent considering this and we found that Life Floor certainly ticked all our boxes!"

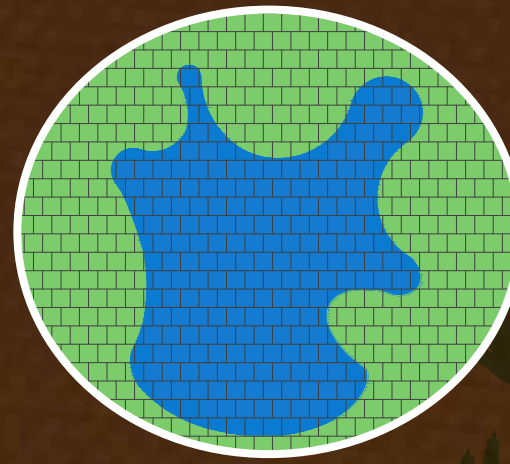

Australia Zoo

Facility: Australia Zoo

Location: Beerwah, Australia

Install Date: March 2018

Installer: Life Floor Australia + New Zealand

Designers: Australia Zoo

Square footage: 2,368 sq ft

Tile: Ripple 2.0

Colors: Bluebird, Lilypad

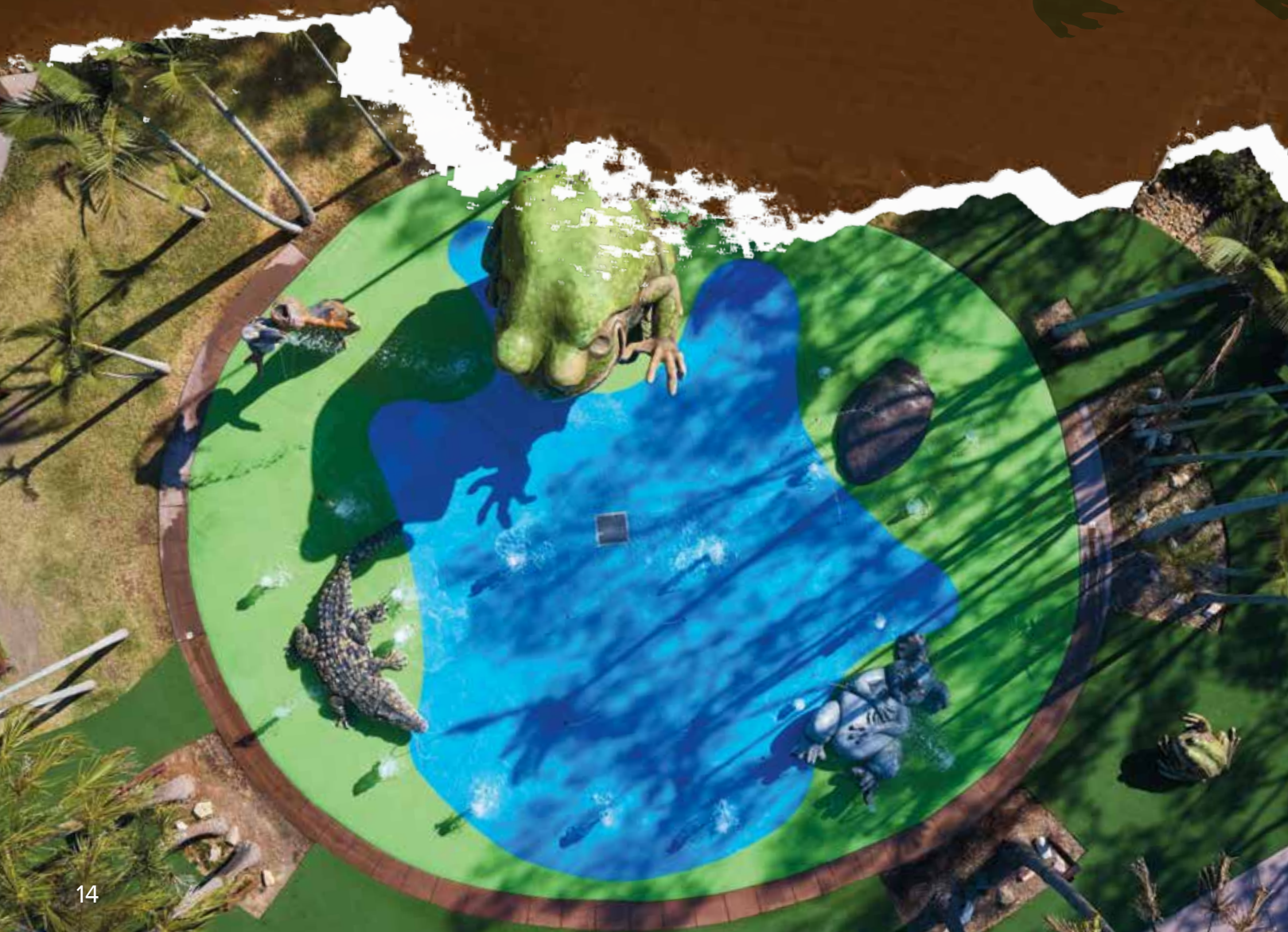



“ We are really pleased with the way Life Floor has immediately transformed the look of Sugarworld and look forward to how our customers enjoying playing on it in the coming summer. ”

Dan Stanford
Capital Works Project Manager
Cairns Regional Council

Connect More At

SUGAR WORLD

Sugarworld Waterpark is pretty sweet. Located near the site of an old sugar mill, this council-owned waterpark is the centerpiece of the lucky community of Edmonton outside Cairns, Australia. The surrounding area, is home to many native species of plants and Australian wildlife, and one not-so-native species of peacock.

As a central place for the community to connect and for local kids to cool off in the Queensland heat, the park features a **7,000 square foot play pool**, complete with a kid’s play structure for kids to climb, spray, splash. The Cairns council knew how important impact cushioning was around the play structure for both safety and play value, but

the poured-in-place surfacing they were using consistently failed, forcing them into a cycle of refurbishment, even though they had never been satisfied with the results. **Life Floor Australia + New Zealand**, along with local Life Floor agent and contractor, **Grassports Australia**, stepped in to offer a better option. The

Life Floor Studio put together a range of different design options for the council to choose from, and the final design took full advantage of Life Floor’s built-in geometry with square, triangles, and **inlaid designs** as a “hidden treasure” for kids climbing to the top of the structure, as well as play point for kids splashing across the surface.

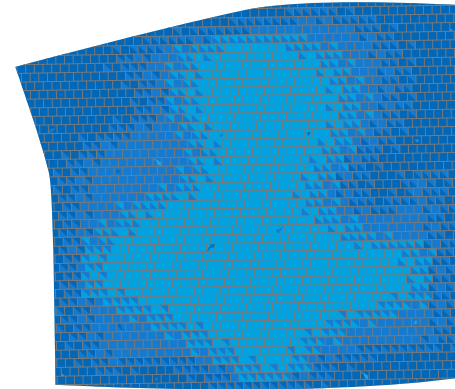

SugarWorld

Facility: SugarWorld Waterpark
Location: Cairns, Queensland, Australia
Install Date: August 2019
Installer: Grassports Australia (Queensland)
Designers: Life Floor
Square footage: 7,000 sq ft
Tile: Ripple 2.0
Colors: Ocean, Bluebird, Aviator



Design More At:

Westfield Splash Pad

Up to the Challenge: Then and Now

In 2014, Westfield, New Jersey brought our team an exciting challenge: they wanted to upgrade their splash pad at **Westfield Memorial Pool Complex** but wanted to preserve the existing design. In 2019, Westfield New Jersey approached us again, this time looking for a refresh that didn't look like any other splash pad we'd ever designed. Prepared to impress, Life Floor Studio put together an octopus-based design that the city fell in love with.

"The design was just so good because we went back and forth at least 3-4 times with different designs, but this time we showed the new one to our staff and they immediately went: THAT ONE." said Heather Re, Aquatic Supervisor of the intricate octopus design

"Now that whole area is just so nice to look at. The whole thing just looks so neat."

The City of Westfield returned to Life Floor Tiles for our quality, safety, and our ability to design anything. They loved the enhancement of Ripple 2.0 for a grippier, more actively slip-resistant option to keep their busy families and guests on their feet.





Westfield Splash Pad

Facility: Westfield Memorial Pool

Location: Westfield, NJ

Install Date: May 2019

Installer: Inside Edge

Designers: Life Floor

Square footage: 2,500 sq ft

Tile: Ripple 2.0

Colors: Aviator, Iceberg, Limelight,
Ocean, Sunshine, and Turquoise



“We like that it’s slip-resistant, of course, and we love the designs we can do, but a lot of it is the customer service. You may pay a bit more, but we’re completely happy with it and we’re never going to go back to concrete. We haven’t had a single major incident of people getting hurt on Life Floor. **It’s worth the peace of mind that the kids are safe.**”

Heather Re, Aquatic Supervisor



In collaboration with:



Vidanta Riviera Maya

Nestled in the middle of 1,000 acres of lush, tropical paradise, **Vidanta Riviera Maya** is home to one of the premier destination experiences in Cancun.

With every possible amenity and luxury at the fingertips of guests, their **Jungala Aquatic Experience** needed to be deeply memorable, relaxing, and fun for every kind of escapist fantasy and let guests feel like they were whisked away to private oasis. It is no wonder that Vidanata trusted Life Floor partner, WhiteWater West Industries, to create their spectacular kid's **Rain Fortress**.



The WhiteWater West structure looks like something straight out of a kid's daydream, packed tight with slides, water-cannons, spray fountains, and waterfalls. And surrounding it all kids can play the day away on Life Floor's slip-resistant and magically designed play surface. With Life Floor in the kids pool, free play is not only possible: it's the norm.

As kids race around delicate colorful arcs, or experiment at the water table, or brace themselves for the drench bucket, they don't need to think twice about getting to the next spray feature. With Life Floor under foot, families soak in the sights, and only worry about what they can't wait to do next.

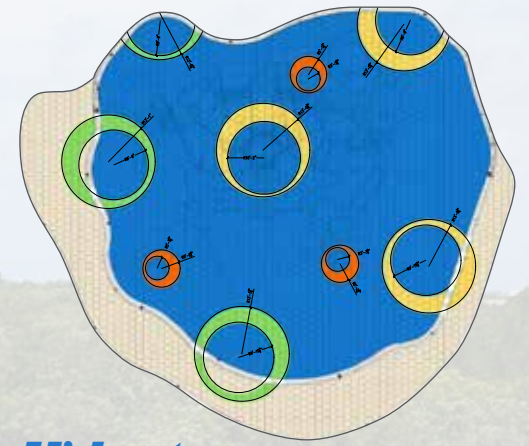

Vidanta Riviera Maya

Facility: Vidanta Riviera Maya
Location: Playa del Carmon, Mexico
Install Date: May 2019
Installer: Elegance
Designers: Life Floor
Square footage: 25,000 sq ft
Tile: Ripple 2.0
Colors: Bluebird, Limelight, Goldfish, Sunshine

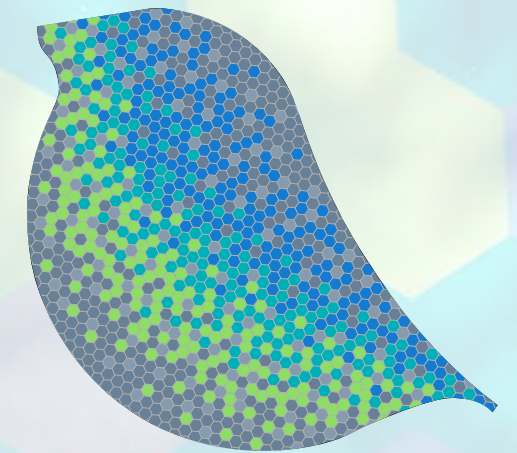
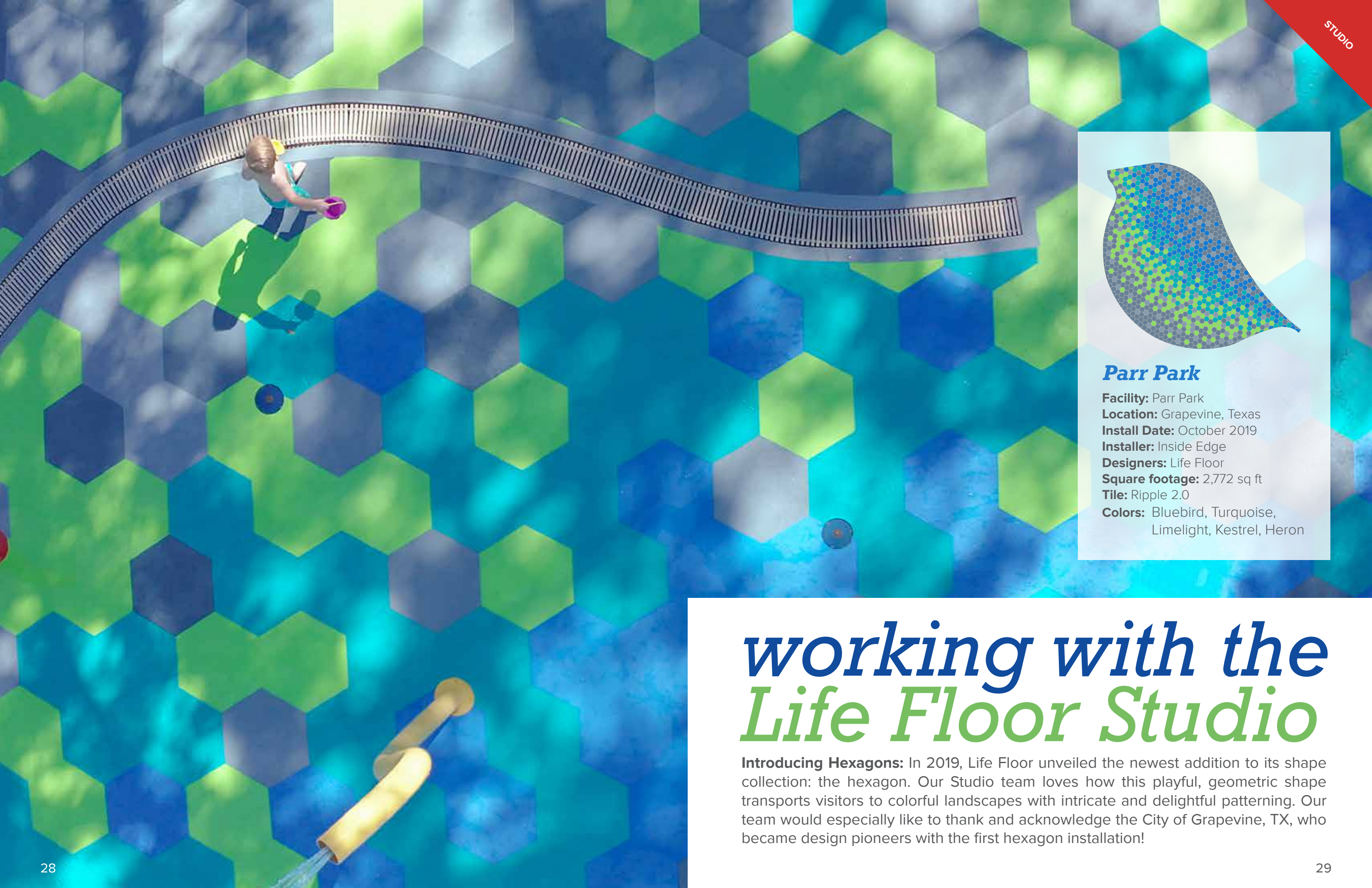

Parr Park

Facility: Parr Park

Location: Grapevine, Texas

Install Date: October 2019

Installer: Inside Edge

Designers: Life Floor

Square footage: 2,772 sq ft

Tile: Ripple 2.0

Colors: Bluebird, Turquoise,
Limelight, Kestrel, Heron

working with the Life Floor Studio

Introducing Hexagons: In 2019, Life Floor unveiled the newest addition to its shape collection: the hexagon. Our Studio team loves how this playful, geometric shape transports visitors to colorful landscapes with intricate and delightful patterning. Our team would especially like to thank and acknowledge the City of Grapevine, TX, who became design pioneers with the first hexagon installation!

Color Options

We've carefully selected our color palette to meet the unique needs of aquatic facilities (and we may have thrown in a few more colors, just for fun). No matter what, our tiles last in extreme hot and cold conditions both indoors and outdoors. For maximum comfort, we suggest our lighter color tiles for outdoor use.

As part of our product offerings, we have created several color families that complement each other well in gradient, geometric, and randomized patterns. Our range of blues is often combined

to create the appearance of water while our range of tans is often used to look like sand. For more subdued environments, many customers opt for our family of greys.

Our Studio team always encourages customers to use 3 or more colors in any given application. Multi-colored floors simply look better and are easier to maintain. The more color and pattern a surface has, the more appealing it is and the harder it is to spot dirt and wear. Be sure to check out our curated themes and patterns for design inspiration.

 <p>Ocean BX.70</p> <p>Pantone®: 2144 RAL: 260 40 40 Hex: 0067B9 sRGB: 0 103 185</p>	 <p>Bluebird BX.50</p> <p>Pantone®: 2172 RAL: 250 60 40 Hex: 147BD1 sRGB: 20 123 209</p>	 <p>Aviator BX.40</p> <p>Pantone®: 2191 RAL: 240 60 40 Hex: 00A3E1 sRGB: 0 163 225</p>	 <p>Iceberg BX.30</p> <p>Pantone®: 2169 RAL: 240 70 15 Hex: 81B0D2 sRGB: 129 176 210</p>	 <p>Onyx GX.90</p> <p>Pantone®: 419 RAL: 000 20 00 Hex: 212322 sRGB: 33 35 34</p>	 <p>Boulevard GX.60</p> <p>Pantone®: Cool Gray 9 RAL: 240 50 05 Hex: 75787B sRGB: 117 120 123</p>	 <p>River Rock GX.50</p> <p>Pantone®: Cool Gray 7 RAL: 000 65 00 Hex: 97999B sRGB: 151 153 155</p>	 <p>Foghorn GX.30</p> <p>Pantone®: Cool Gray 6 RAL: 000 70 00 Hex: A7A8AA sRGB: 167 168 170</p>	 <p>Porcelain PX.10</p> <p>Pantone®: 9064 RAL: 110 92 05 Hex: F1F1DE sRGB: 241 241 222</p>		
 <p>Kestrel BC.60</p> <p>Pantone®: 2165 RAL: 230 50 10 Hex: 588197 sRGB: 104 129 151</p>	 <p>Heron BC.30</p> <p>Pantone®: 2163 RAL: 230 60 10 Hex: 369CAE sRGB: 134 156 174</p>	 <p>Turquoise TX.50</p> <p>Pantone®: 7466 RAL: 190 60 45 Hex: 00B0B9 sRGB: 0 176 185</p>	 <p>Aqua TX.30</p> <p>Pantone®: 317 RAL: 190 80 25 Hex: B1E4E3 sRGB: 177 228 227</p>	 <p>Sandstone MX.20</p> <p>Pantone®: 9180 RAL: 085 90 10 Hex: F3E4CD sRGB: 243 228 205</p>	 <p>Ivory MX.10</p> <p>Pantone®: 9184 RAL: 095 90 10 Hex: EFE4CE sRGB: 239 228 206</p>	 <p>Terra Cotta RW.70</p> <p>Pantone®: 2441 RAL: 040 40 30 Hex: A76E5E sRGB: 167 110 94</p>	 <p>Evergreen LW.70</p> <p>Pantone®: 2244 RAL: 170 50 35 Hex: 1B806D sRGB: 27 128 109</p>	 <p>Olive LW.40</p> <p>Pantone®: 7494 RAL: 130 70 20 Hex: 9CAF88 sRGB: 156 175 136</p>	 <p>Lilypad LX.50</p> <p>Pantone®: 2464 RAL: 130 70 40 Hex: 78BD70 sRGB: 120 189 112</p>	 <p>Limelight LX.40</p> <p>Pantone®: 7487 RAL: 120 70 70 Hex: 8EDD65 sRGB: 142 221 101</p>
 <p>Sepia MX.70</p> <p>Pantone®: 7582 RAL: 050 60 20 Hex: 674736 sRGB: 103 71 54</p>	 <p>Tiki MX.60</p> <p>Pantone®: 2312 RAL: 060 60 20 Hex: B79A81 sRGB: 183 154 129</p>	 <p>Mojave MX.50</p> <p>Pantone®: 4665 RAL: 070 70 20 Hex: CDA788 sRGB: 205 167 136</p>	 <p>Gobi MX.40</p> <p>Pantone®: 4675 RAL: 070 80 20 Hex: DCBFA6 sRGB: 220 191 166</p>	 <p>Sandbar MX.30</p> <p>Pantone®: 7506 RAL: 080 90 20 Hex: EFD8B2 sRGB: 239 219 178</p>	 <p>Goldfish OX.40</p> <p>Pantone®: 1505 RAL: 050 60 80 Hex: FF6900 sRGB: 255 105 0</p>	 <p>Iris VX.60</p> <p>Pantone®: 2587 RAL: 310 40 40 Hex: 8246AF sRGB: 130 70 175</p>	 <p>Platypus FX.50</p> <p>Pantone®: 3527 RAL: 340 50 45 Hex: D12B92 sRGB: 209 43 146</p>	 <p>Pomegranate RX.50</p> <p>Pantone®: 1807 RAL: 020 40 50 Hex: A4343A sRGB: 164 52 58</p>	 <p>Sunshine YX.50</p> <p>Pantone®: 120 RAL: 095 90 59 Hex: FBDB65 sRGB: 251 219 101</p>	

Introducing Themes

Searching for a multi-color combination that fits your aquatic project? Our design team has curated a number of themes to fit a wide variety of facilities. While these pre-configured themes help to streamline the design process, they can also be used as starting points for inspiration. Life Floor can be designed with any variation of these themes by substituting a color or two or by creating an entirely new combination of colors to best complement the theming and branding of any facility.

Themes

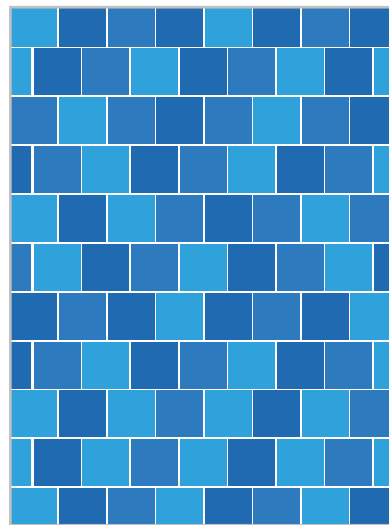

High Tide

Our most popular aquatic theme, pairs well with ocean life and bubble die-cuts. High UV-resistance perfect for outdoor applications, including multi-level play structures and splash pads.



Ocean, BX.70
Pantone®: 2144
RAL: 260 40 40



Bluebird, BX.50
Pantone®: 2172
RAL: 250 60 40



Aviator, BX.40
Pantone®: 2191
RAL: 240 60 40

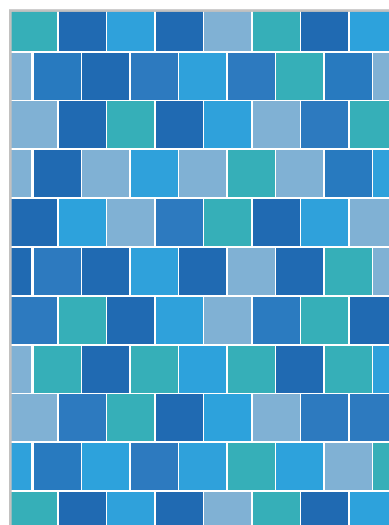

Lagoon

A variant aquatic theme, this combination works especially well with splash pads, or in a mosaic for resort-style pool decks.



Ocean, BX.70
Pantone®: 2144
RAL: 260 40 40



Bluebird, BX.50
Pantone®: 2172
RAL: 250 60 40



Aviator, BX.40
Pantone®: 2191
RAL: 240 60 40



Turquoise, TX.50
Pantone®: 7466
RAL: 190 60 45



Iceberg, BX.30
Pantone®: 2169
RAL: 240 70 15

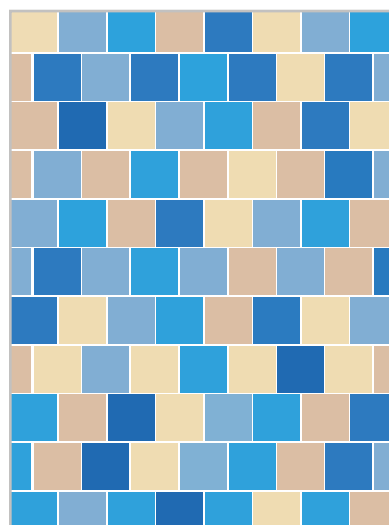

Seashore

This theme is often used for designs evoking shorelines, ponds, and islands. Especially popular for water parks and on splash pads. Pair with shells and other ocean life die-cuts.



Bluebird, BX.50
Pantone®: 2172
RAL: 250 60 40



Aviator, BX.40
Pantone®: 2191
RAL: 240 60 40



Iceberg, BX.30
Pantone®: 2169
RAL: 240 70 15



Gobi, MX.40
Pantone®: 4675
RAL: 070 80 20



Sandbar, MX.30
Pantone®: 7506
RAL: 080 90 20

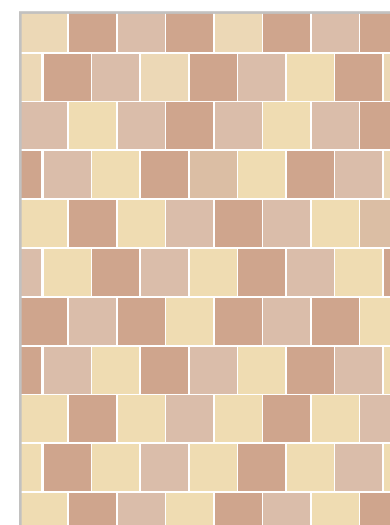

Montauk

Another popular pool deck theme, this one is also popular in community centers, indoors and outdoors.



Mojave, MX.50
Pantone®: 4665
RAL: 070 70 20



Gobi, MX.40
Pantone®: 4675
RAL: 070 80 20

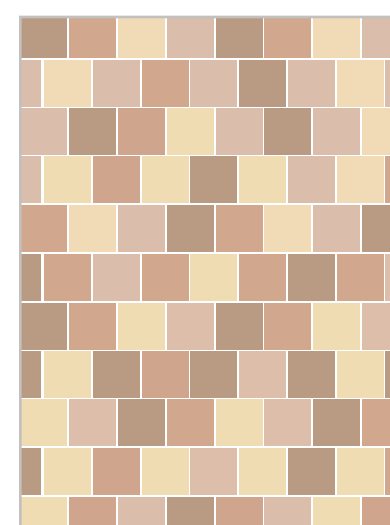

Zuma

This theme is preferred for pool decks, especially in resorts, hotels, indoors and outdoors.



Tiki, MX.60
Pantone®: 2312
RAL: 060 60 20



Mojave, MX.50
Pantone®: 4665
RAL: 070 70 20



Gobi, MX.40
Pantone®: 4675
RAL: 070 80 20



Sandbar, MX.30
Pantone®: 7506
RAL: 080 90 20

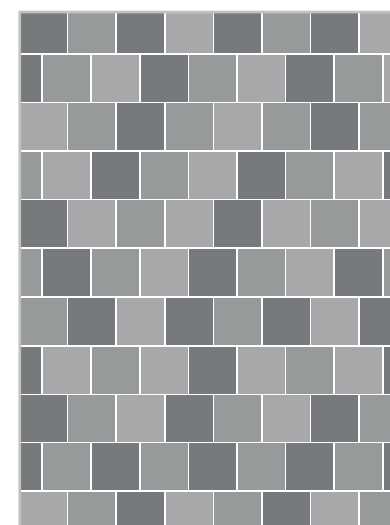

Boulder

High-UV resistance theme, perfect for public parks and splash pads.



Boulevard, GX.60
Pantone®: Cool Gray 9
RAL: 240 50 05



River Rock, GX.50
Pantone®: Cool Gray 7
RAL: 000 65 00

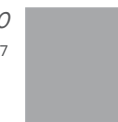

Foghorn, GX.30
Pantone®: Cool Gray 6
RAL: 000 70 00

Themes Continued

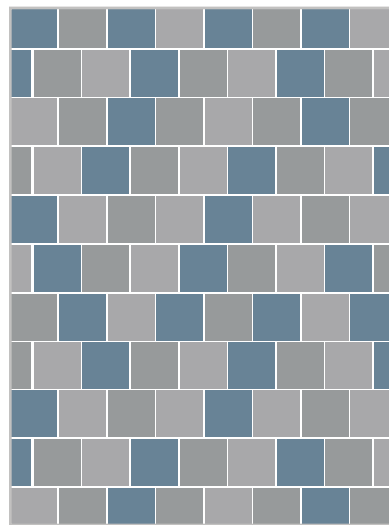

Cascade

Another high-UV resistance theme, perfect for municipal pools.

- 

Kestrel, BC.60
Pantone®: 2165
RAL: 230 50 10
- 

River Rock, GX.50
Pantone®: Cool Gray 7
RAL: 000 65 00
- 

Foghorn, GX.30
Pantone®: Cool Gray 6
RAL: 000 70 00

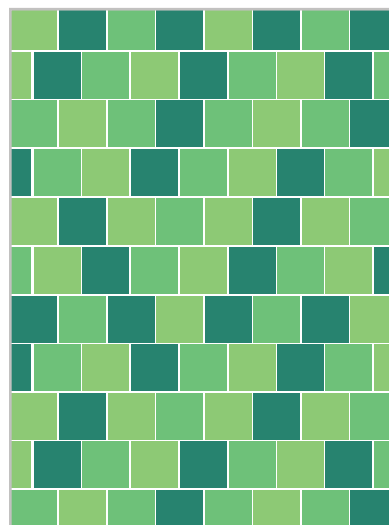

Rainforest

Great for splash pads and multi-level play structures at zoos, pairs with tropical wildlife diecuts.

- 

Evergreen, LX.70
Pantone®: 2244
RAL: 170 50 35
- 

Lilypad, LX.50
Pantone®: 2464
RAL: 130 70 40
- 

Limelight, LX.40
Pantone®: 7487
RAL: 120 70 70

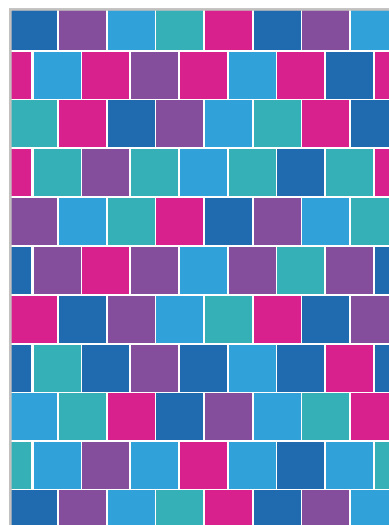



Wildflower

This theme is popular in applications for young children, especially splash pads.

- 

Ocean, BX.70
Pantone®: 2144
RAL: 260 40 40
- 

Aviator, BX.40
Pantone®: 2191
RAL: 240 60 40
- 

Turquoise, TX.50
Pantone®: 7466
RAL: 190 60 45
- 

Iris, VX.60
Pantone®: 2587
RAL: 310 40 40
- 

Platypus, FX.50
Pantone®: 3527
RAL: 340 50 45

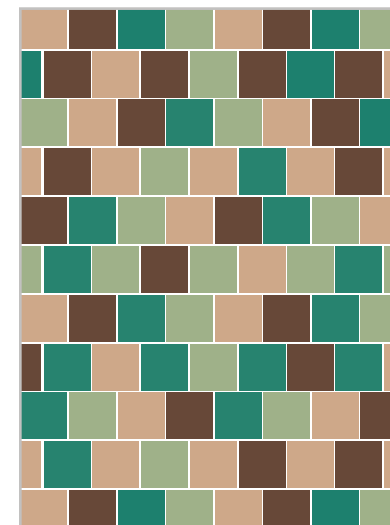

Wilderness

A blend of colors inspired by the forest to evoke the feeling of being in the great outdoors.

- 

Sepia, MX.70
Pantone®: 7582
RAL: 050 40 20
- 

Tiki, MX.50
Pantone®: 2312
RAL: 060 60 20
- 

Evergreen, LW.70
Pantone®: 2244
RAL: 170 50 35
- 

Olive, LW.40
Pantone®: 7494
RAL: 130 70 20

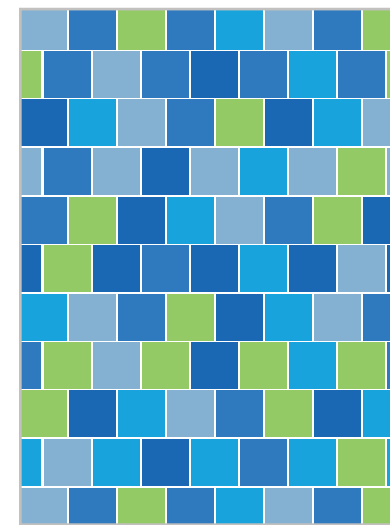

Oasis

A vibrant mix of blue and green for a bright design that works well with our geometric tile options.

- 

Ocean, BX.70
Pantone®: 2144
RAL: 260 40 40
- 

Bluebird, BX.50
Pantone®: 2172
RAL: 250 60 40
- 

Aviator, BX.40
Pantone®: 2191
RAL: 240 60 40
- 

Iceberg, BX.30
Pantone®: 2169
RAL: 240 70 15
- 

Limelight, LX.40
Pantone®: 7487
RAL: 120 70 70



Rectangles

The Versatile Form

Our rectangular tiles present the opportunity to design with a popular 1' x 2' grid or to create long plank effects by aligning tiles of the same color in a row. They enable designers to create more modern, geometric patterns and, like our other shapes, rectangles can be arranged as gradients or they can be used to break up solid fields of color with bright accents. Try varying the rotation of these tiles to achieve a really dynamic look.

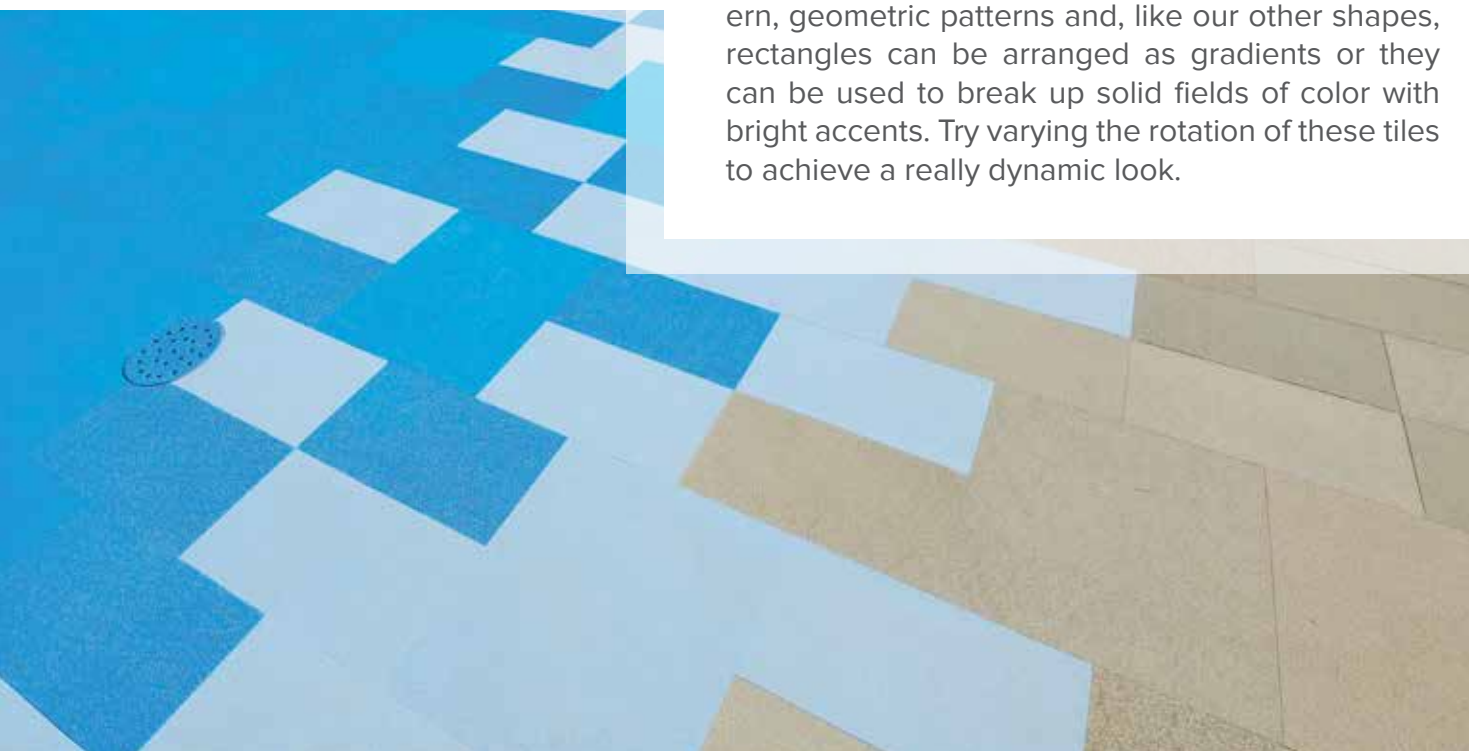

Hexagons

Our Newest Shape

We're still experimenting with hexagons, and we're looking forward to seeing what our partners come up with, as well. What we do know is that the hexagon's additional sides add immediate visual complexity to any space, without the need for additional design work or custom cutting.

Hexagons lend themselves to radial designs, and thus are perfect for splash pads.

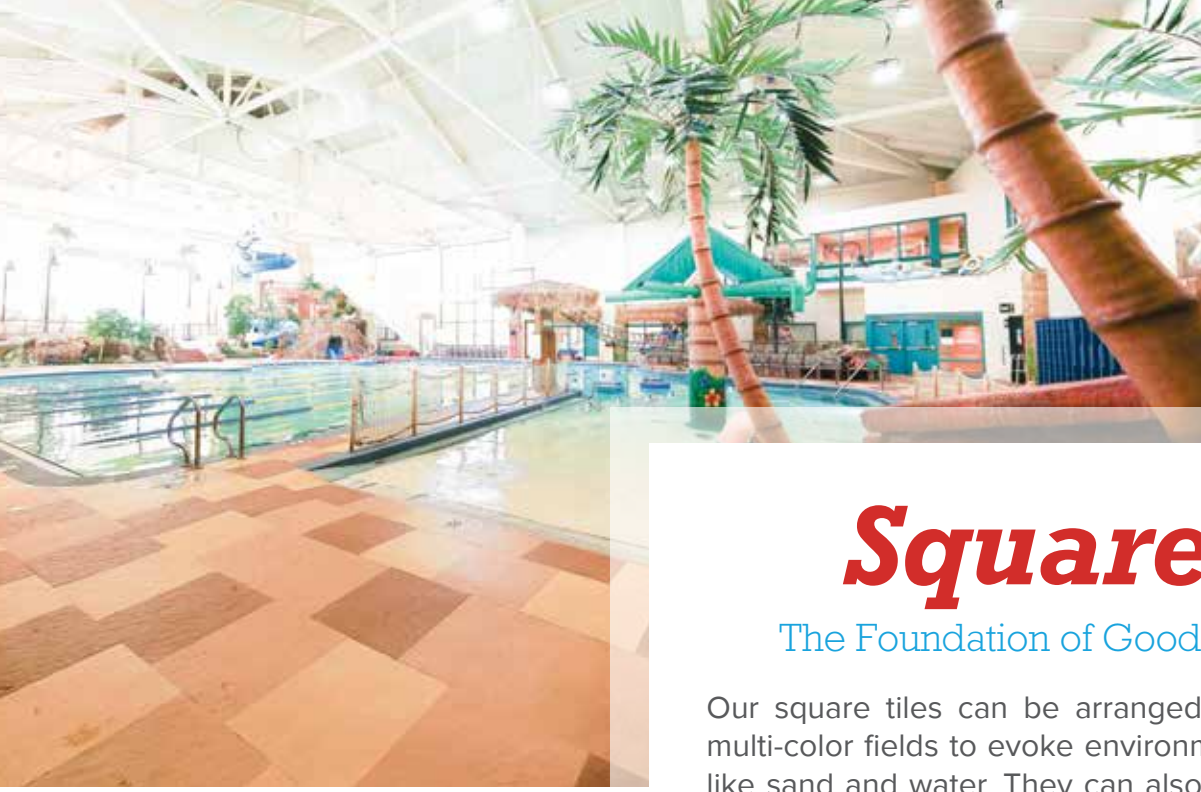

Squares

The Foundation of Good Design

Our square tiles can be arranged in randomized multi-color fields to evoke environmental elements like sand and water. They can also be arranged in colorful gradient patterns using a range of tones from our palette. For a more classic design, squares look great when arranged in a checkerboard grid. For a more modern effect, square tiles of the same color can be installed consecutively to form long, rectangular configurations. Some facilities have even opted for a staggered zig-zag effect. While the original shape of our tiles may be simple, it is filled with the potential to create both beautiful and cost-effective design solutions.

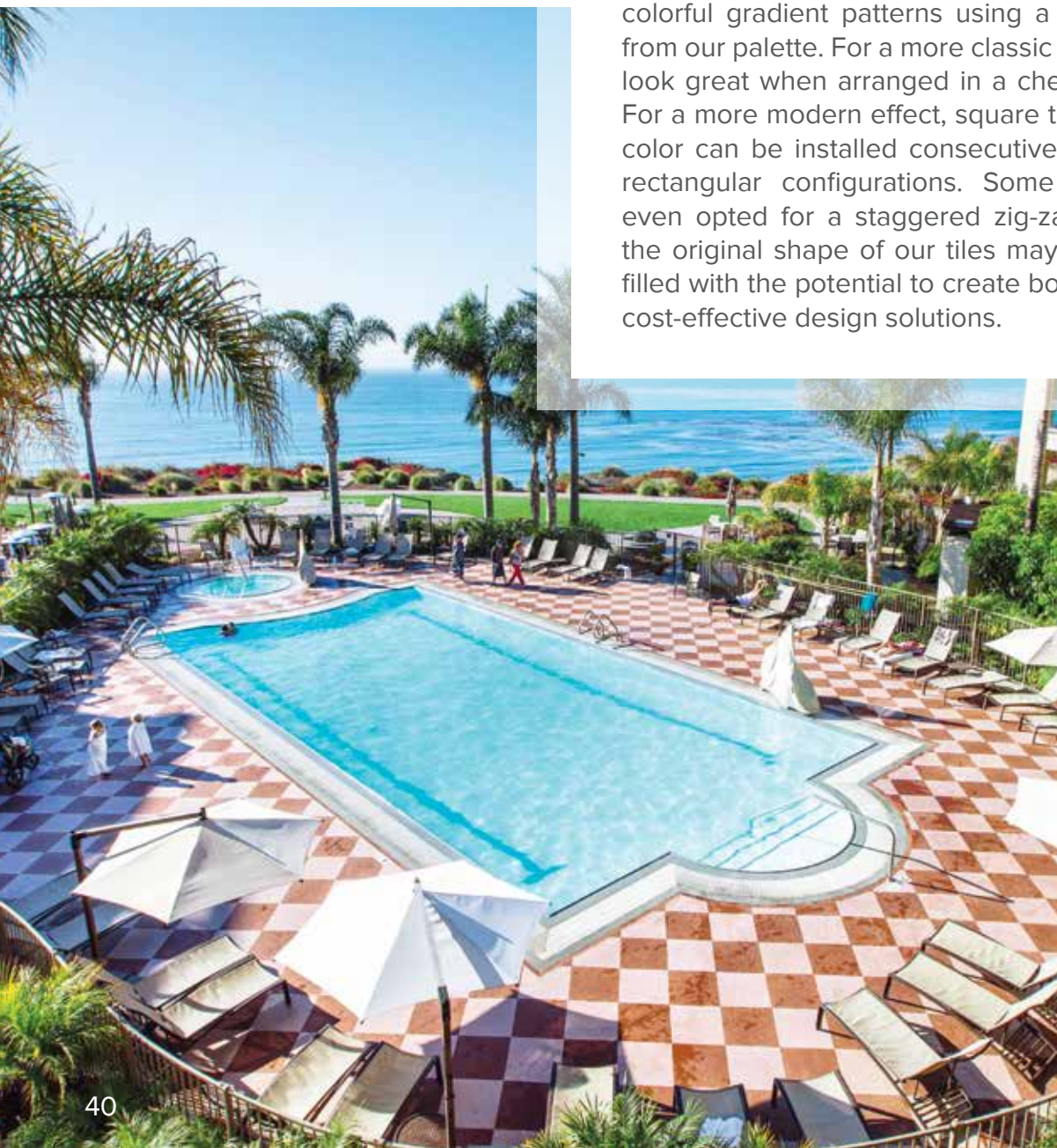



Triangles

The Cutting Edge

By simply cutting our tiles in half to form right triangles, we've created a world of new design opportunities. These tiles have been the most popular choice when creating gradient effects, especially when mimicking coastlines. They're also an excellent choice when adding accents of color around a facility. For a more geometric approach, mirrored triangles can be arranged to create an even larger pattern.





Inlaid Designs

A Color Palette for Every Theme and Occasion

Inlaid shapes provide an extra touch that adds visual interest to aquatic environments and reinforces branding. The following inlays represent some of Life Floor's ever-expanding library of pre-designed options, including several shapes that match aquatic themes.

These shapes are a fun and cost-effective way to add theming and visual interest to any installation. All inlays are cut at a Life Floor manufacturing site in the USA and are ready for installation at the customer's facility. Inlays can be made in any color

and at virtually any size. We can fit several of one shape within a single tile or we can blow up a shape up to cover several tiles. The possibilities are endless.

We're always adding to our catalog of inlaid shapes. If you'd like something specific for your design, let us know - our designers can almost definitely make it.

Here are a few of our favorites:



Crab



Seahorse



Seashell



Small Fish



Medium Fish



Large Fish



Small Bubble



Large Bubble



Seagrass



Maple Leaf



Starfish

Interested in a custom design for your installation? Contact us at: solutions@lifefloor.com

Inlaid Design Spotlight

In collaboration with:



Fun Spot America keeps its vibrant edge in the entertainment scene by creating lasting, amazing experiences for their guests.

For its new phase of development, Fun Spot approached **Martin Aquatic** to create an exciting, interactive water feature to serve as a landmark attraction across their Orlando theme park. We spoke with **Martin Aquatic Design Studio Manager, Maya Mendelewicz**, about their design process for this hit attraction:

“We wanted to take Fun Spot’s motto of “Safe-Clean-Fun” to heart, which is why we turned to Life Floor with its state-of-the-art slip-resistant soft flooring. Working together with the owners of Fun Spot, we talked about how this new interactive water feature would be seen from many different angles—from the two-story carousel to the park’s 100-foot-tall Ferris Wheel. With that in mind, and the flexibility of embedding custom-designed art into the splash pad’s surface, we developed a floor pattern that would primarily focus on Fun Spot’s logo.”

The complexity of the Fun Spot logo presented a challenge when Martin Aquatic translated the image from the computer to an inlaid design made of Life Floor tiles. “It was really about simplifying it and making it work with Life Floor. We had to be aware of where the cuts would need to go, and had to think about which colors in their logo would make the design more clean and visible. Although it’s a simple pattern, it was important to us to use colors like sunshine to make the floor pop throughout the design.”



Fun Spot

Facility: Fun Spot Waterpark

Location: Orlando, FL

Install Date: August 2019

Installer: Inside Edge

Designers: Life Floor and
Martin Aquatic

Square footage: 3,889 sq ft

Tile: Ripple 2.0

Colors: Bluebird, Porcelain,
Sunshine, Aviator

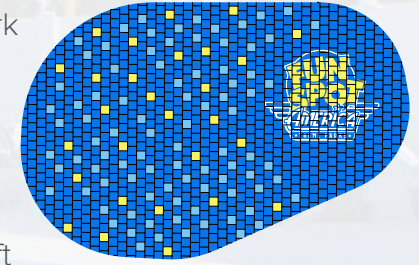

Patterns

To make multi-color floors easier to design, our designers have curated a series of tile arrangements to fit the needs of virtually any aquatic space, whether a water park, splash pad, municipal center, or resort swimming pool.

Our pre-arranged patterns have been created around our specific tile shapes. By arranging Life Floor tiles in a random order,

we create a mottled effect, and by arranging them according to color value, we can create a gradient. Cutting tiles, whether into triangles, waves, or other shapes, can further complete the look. These pages show some basic pattern possibilities with our square, triangle, rectangle, and hexagon tiles but really the options are limitless!

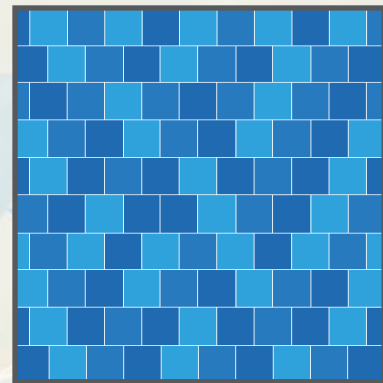

301

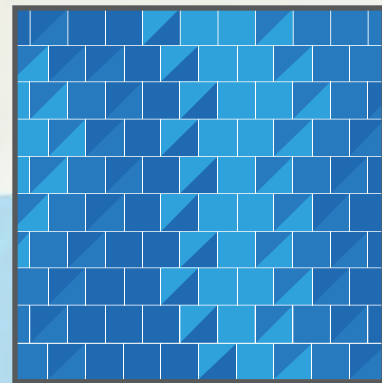

302

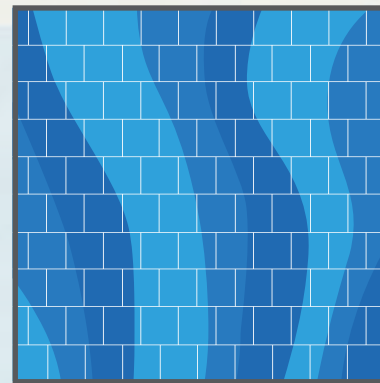

303

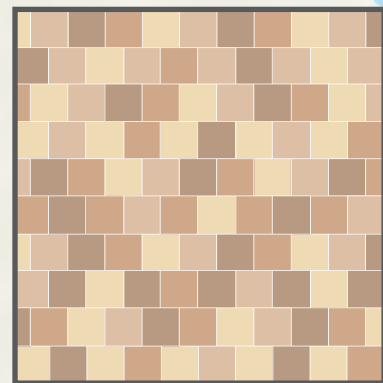

401

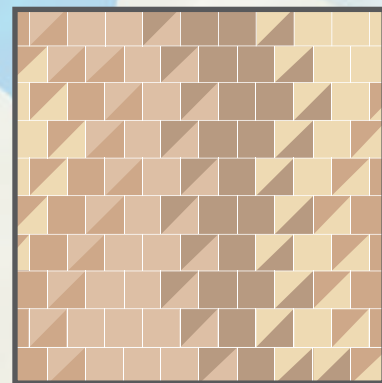

402

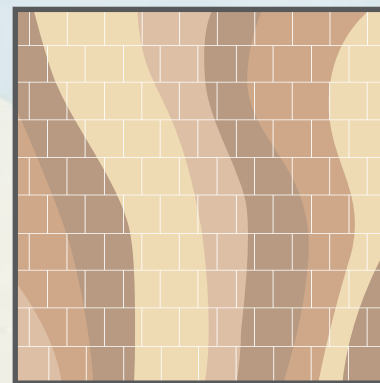

403

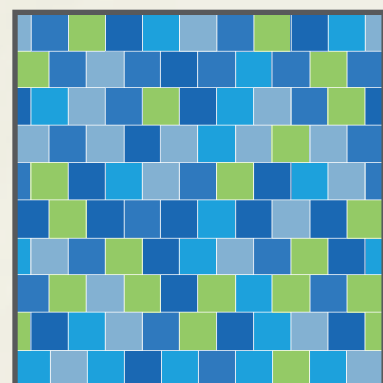

501

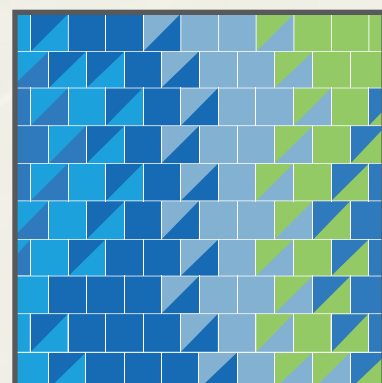

502

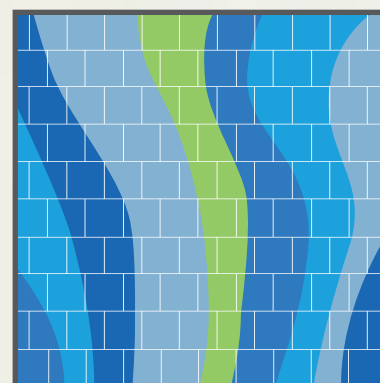

503

Think Outside the Box.

In 2019, Life Floor introduced two new shape patterns: hexagon and rectangle. With a larger design toolbox to play with, architects and A+D firms are equipped to take their aquatic environments to the next level. Interested in standing out from the pack? Upgrade your aquatic installation with one of these innovative designs.

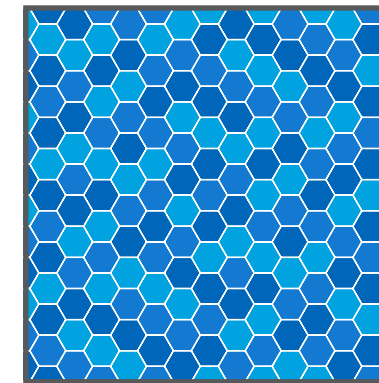

304

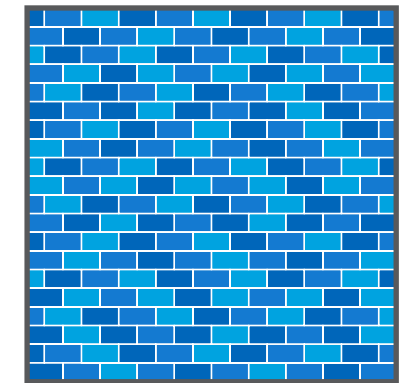

305

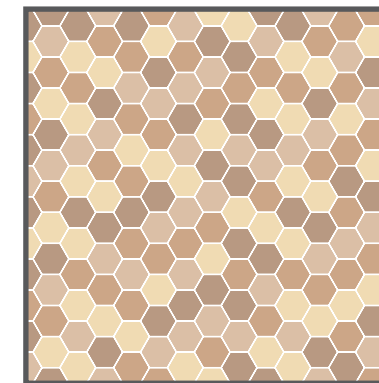

404

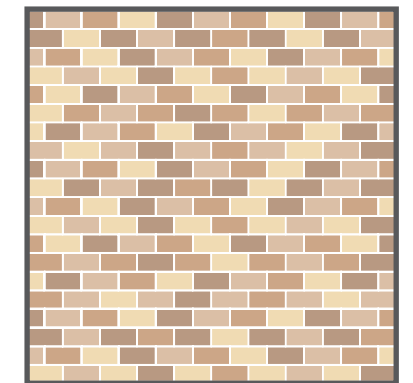

405

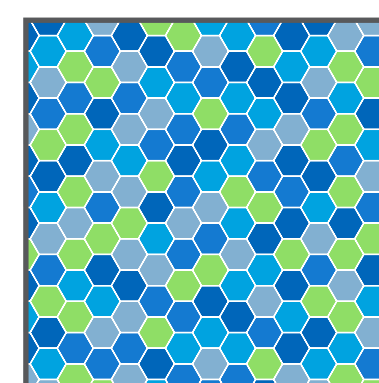

504

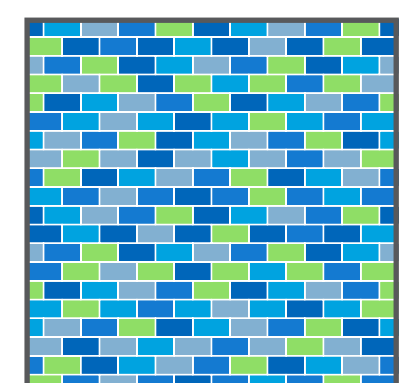

505



Certified to
NSF/ANSI Standard 50

Ripple 2.0 in 3/8" is certified to the NSF/ANSI 50 standard for interactive water play venues.

Visit lifefloor.com/nsf50

A more tactile surface that looks and feels as slip-resistant as it is.

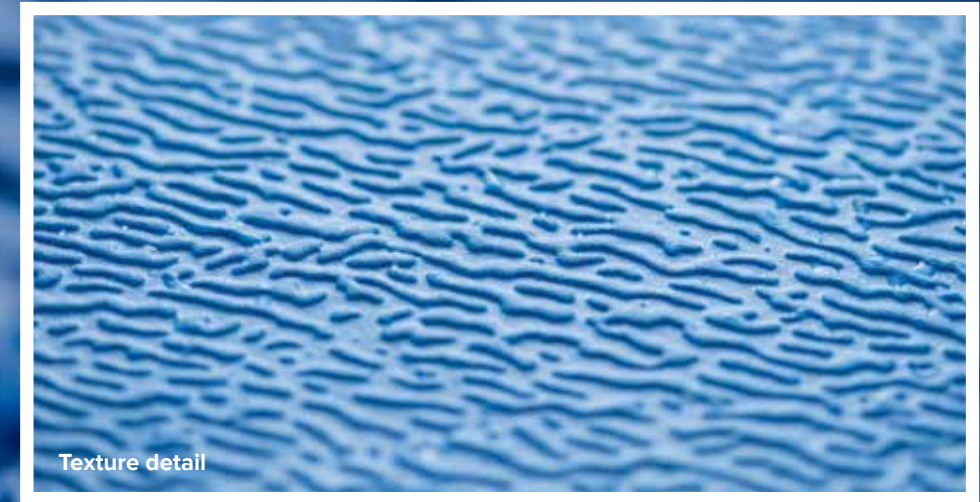

Texture detail

A gentle deterrent

When encountering a safety surface as comfortable as Life Floor, some guests like to really push the limits of physical activity. As a gentle reminder that safety is everyone's responsibility, Ripple's new, improved texture features a more tactile grip, while still maintaining the comfortable, non-abrasive surface you expect from Life Floor.

More dramatic relief

Deeper grooves also mean a more defined texture, and a crisper, more polished look for your aquatic facility.



Ripple 2.0 is featured on our Westfield Splash Pad

Texture Spotlight: Ripple 2.0

Designed to fight hydroplaning

Believe it or not, Ripple has always worked on the same principle as your car's all-weather tires. Grooves called siping allow water to run away from the surface into channels, ensuring that the tire is actually meeting the road, or in our case, that your foot is hitting the floor. Our engineers discovered that by increasing the depth of Ripple's grooves by 75%, we could not only increase overall traction, but specifically increase protection against hydroplaning.

Improved traction overall

In accordance with the new NSF:50 standards, we utilize the British Pendulum Test for surface slip-resistance, which we believe best reproduces real-world conditions in the laboratory testing environment. Recommended British Pendulum Numbers (BPN) for splash pad is over 40. Conventional surfaces, like concrete, have a BPN ranging between 36-42. Ripple Classic has a top BPN of 44, and Ripple 2.0 has a BPN of 58. With a BPN nearly 40% greater than concrete, without being abrasive, Ripple 2.0 is our most slip-resistant texture ever!

Texture Spotlight: Slate

To perfect our slate texture, we created an entirely new mold by laser-scanning actual stone. Scanning at greater than 100%, we were able to better preserve the look of real slate. Finally, the best parts of each sample were digitally combined to create the perfect Life Floor texture.



What is Micro-Tread™?

The biggest improvement to our **Slate** texture is something small. Look closely, and you'll notice tiny ridges and grooves, similar to **Ripple** tiles.

Micro-tread increases the traction of our **Slate** texture while still allowing the beauty of natural stone to shine through.

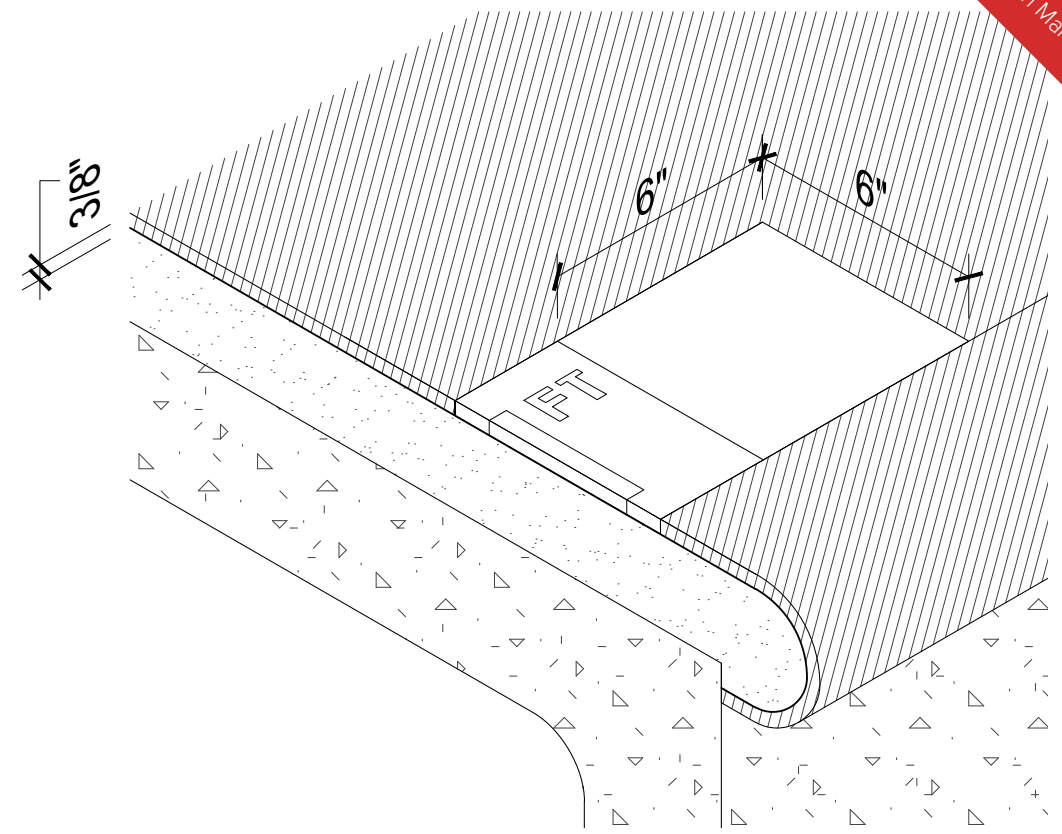

Depth Markers

Never use another ceramic depth marker.

Our depth markers are die cut from contrasting colored tile, which means the **symbols will never fade**. They're made from the same material as our Life Floor tiles, which means they'll **never shatter** like ceramic markers. They feature our famous Ripple texture, which means they're slip-resistant like the rest of our products.

Perfect with any Life Floor installation, or in place of conventional ceramic depth markers in any aquatic facility.

To learn more, visit: lifefloor.com/depth-markers

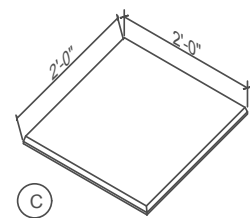
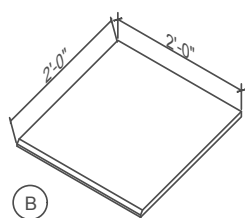
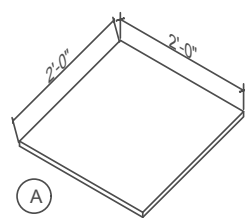
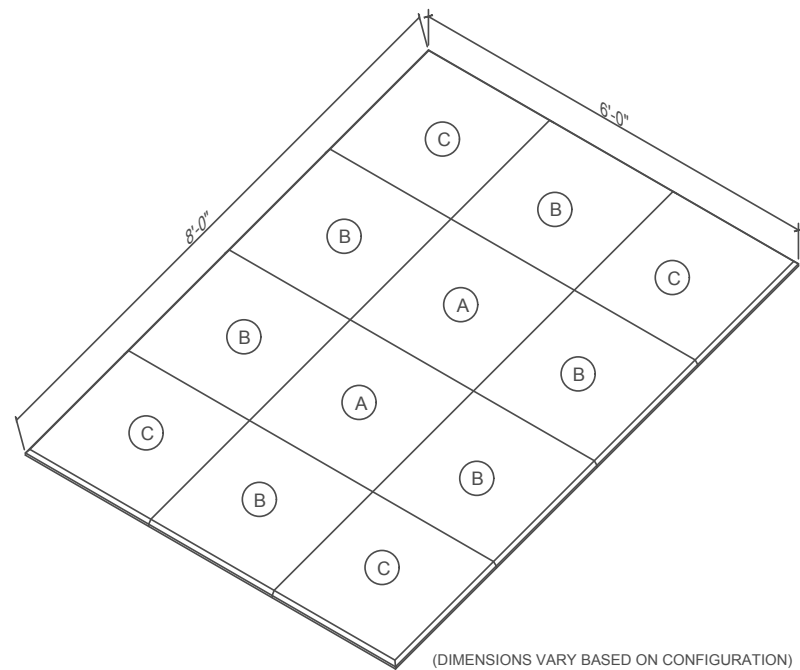

Slide Pads

Life Floor makes the best slide pads money can buy, and we do it for about half the cost of the competition.

Designed to meet the safety and quality standards of today's most challenging water park applications, 7/8" slide pad tiles will never absorb water and remain slip-resistant even when submerged.



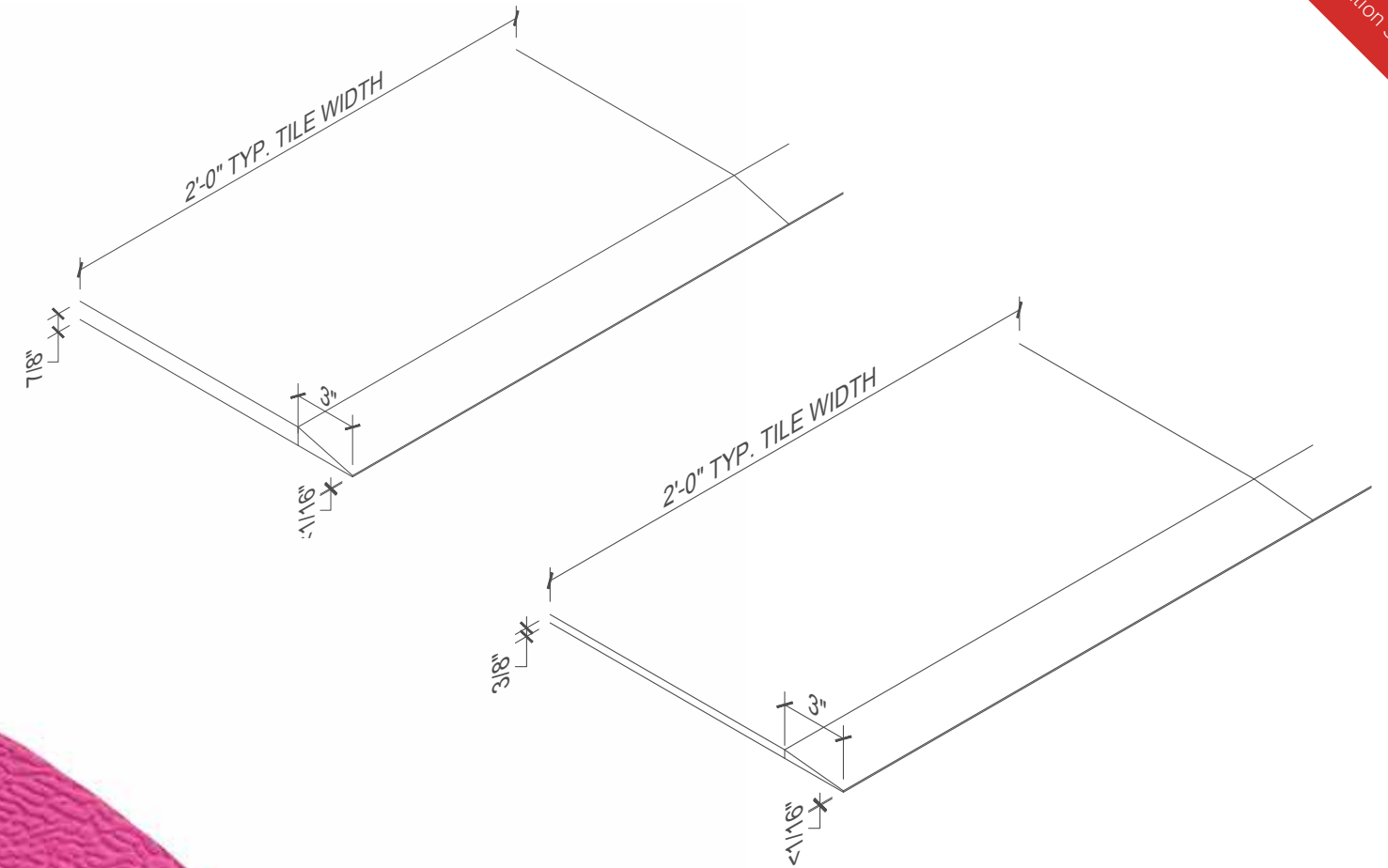
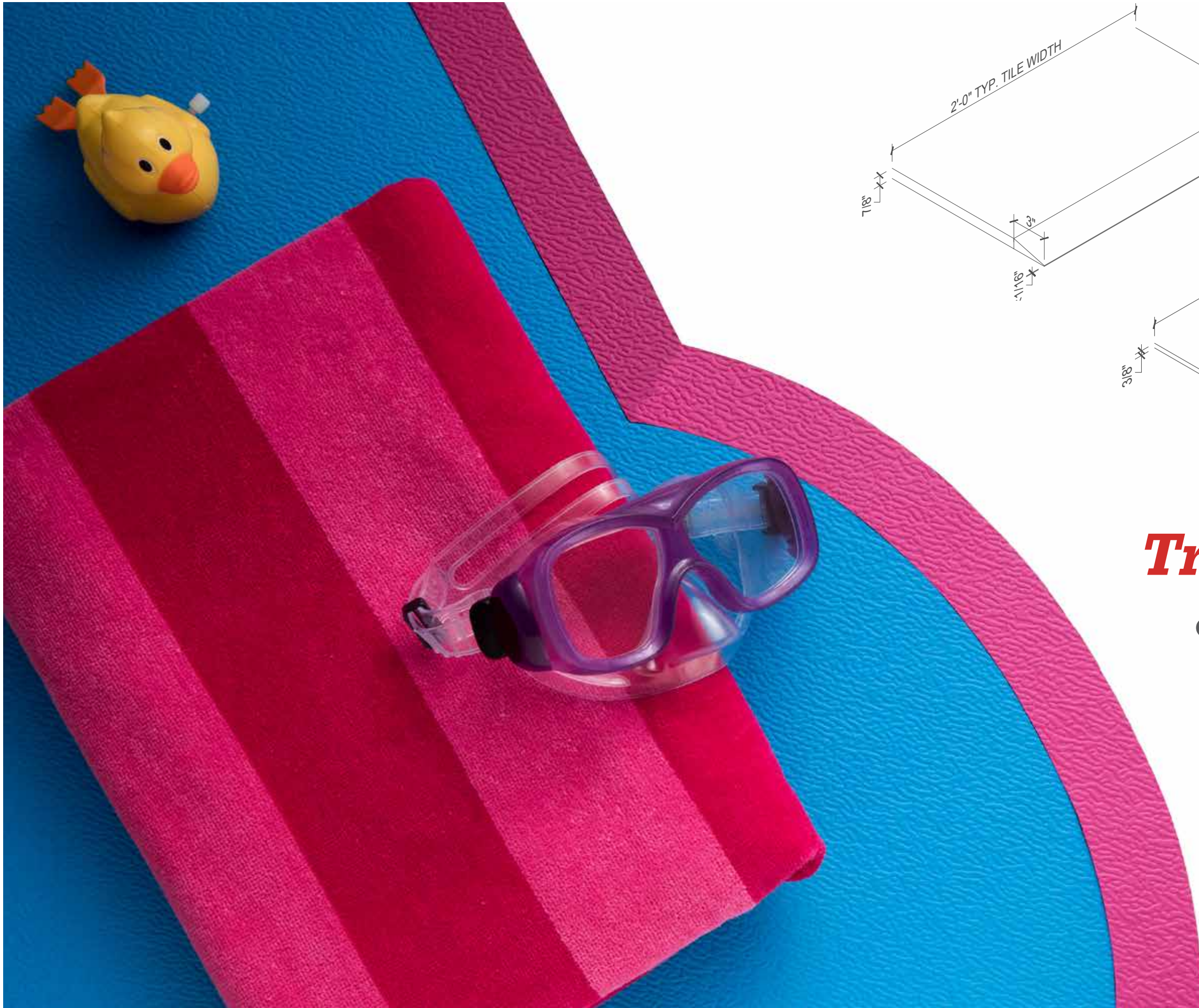

Transition Strips

Our transition strips make the grade. Available to accompany tiles in $\frac{3}{16}$ ", $\frac{3}{8}$ ", and $\frac{7}{8}$ " thickness and fabricated at our manufacturing line in South Dakota, they eliminate tripping hazards and provide a smooth, finished appearance to any installation.

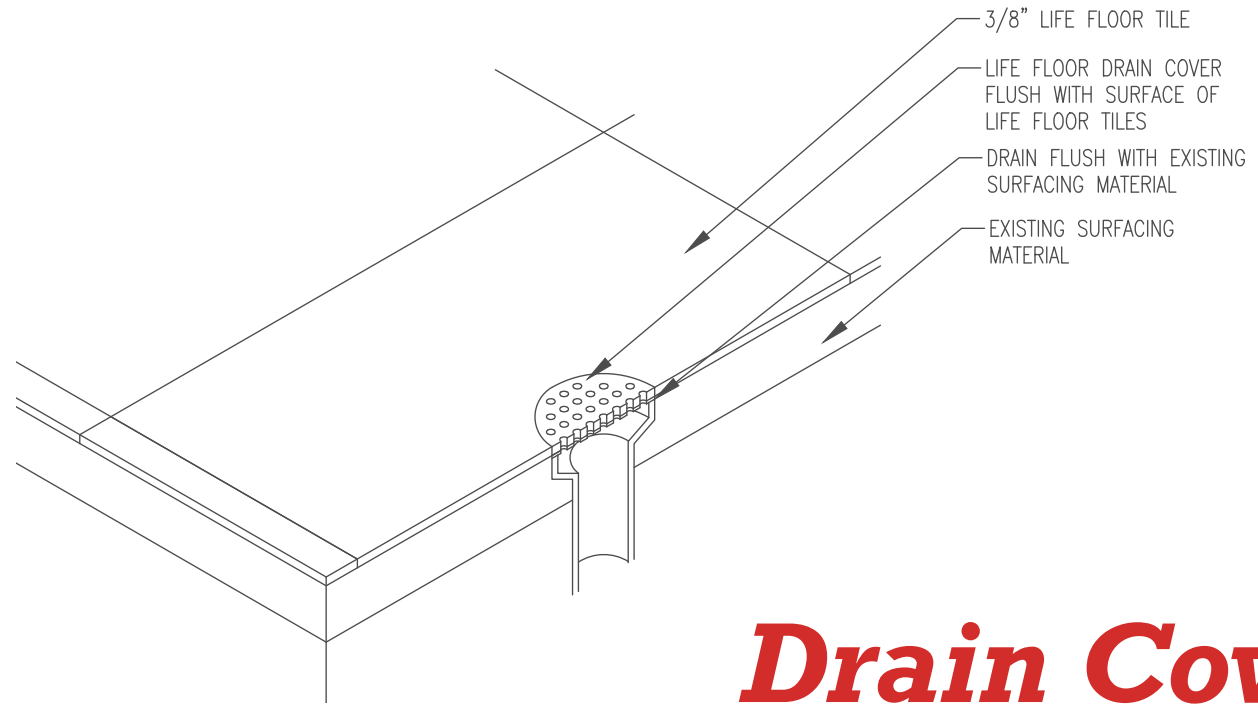

Drain Covers

Drains are easy to fit with Life Floor. We simply measure the drain, cut a piece to fit, and arc punch holes to ensure proper drainage.

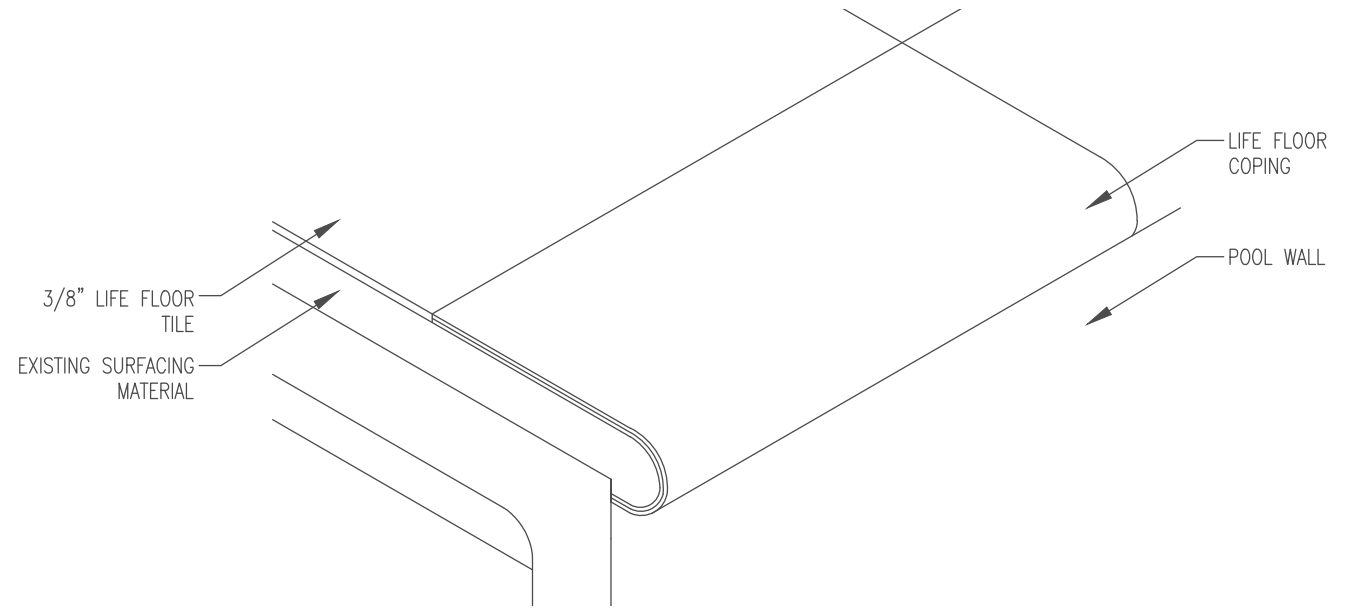
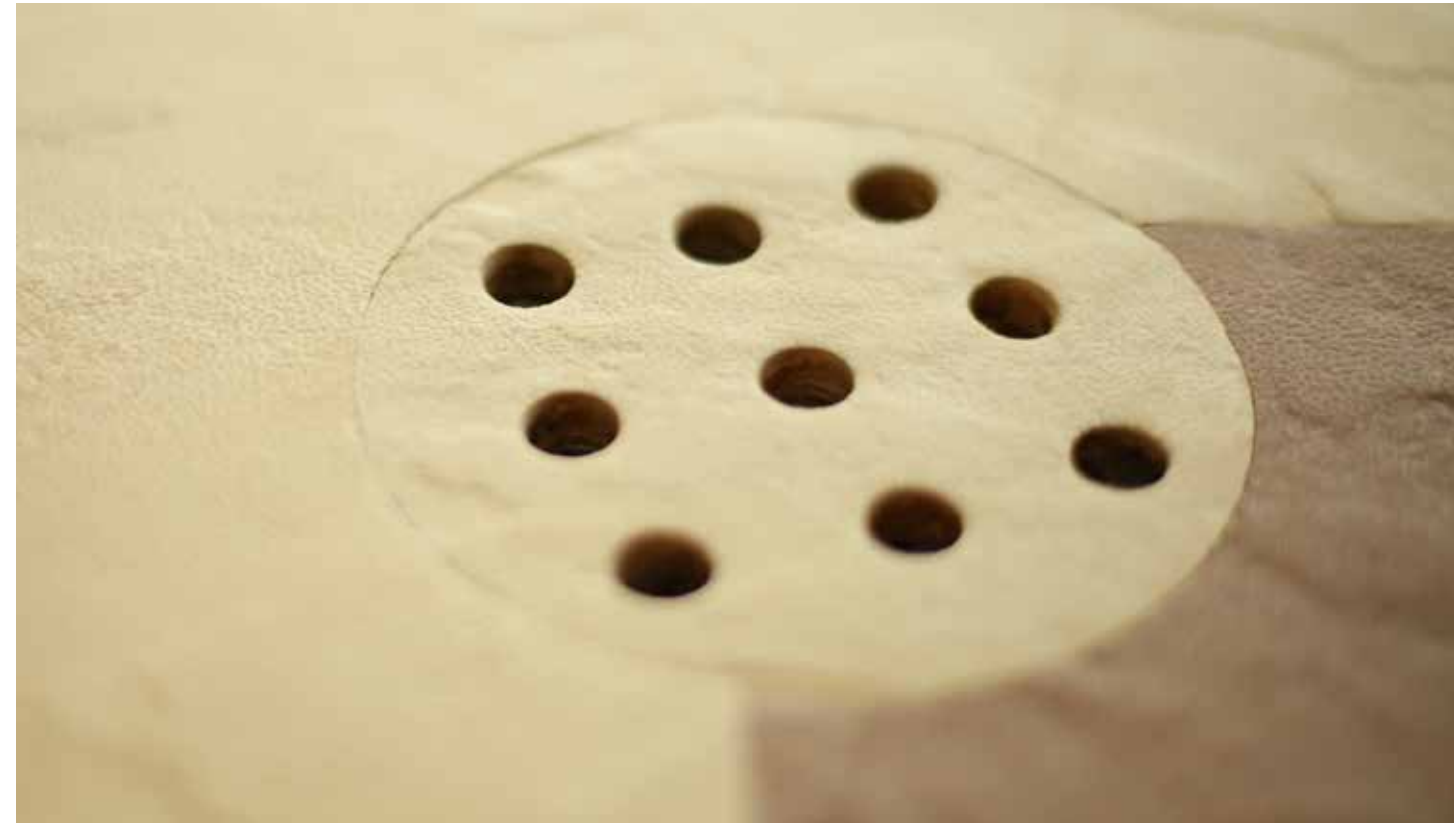
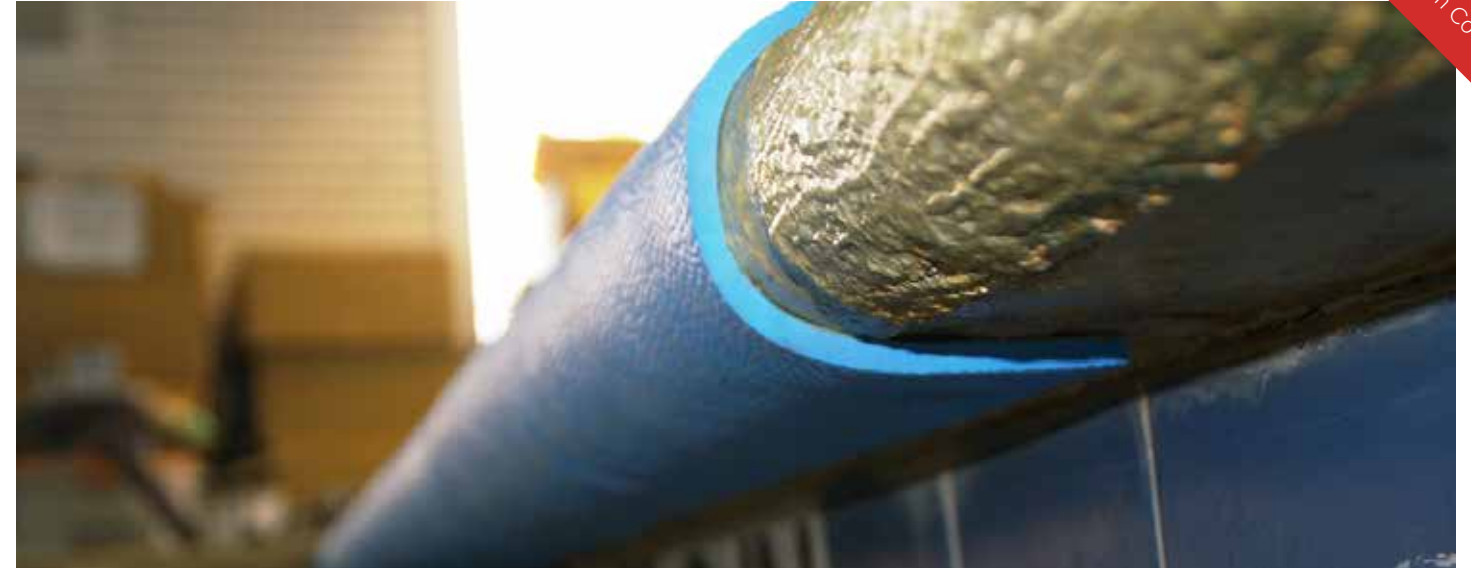

Coping + Wraps

Our 3/16" coping pieces are designed with the flexibility to wrap coping, edge nosing, and staircases to bring Life Floor to the very edge of your pool or play structure.

This solution enables a continuous application of our product to provide a cohesive, overall design solution while increasing safety at the very points where injuries often occur.



Applications

Your feet will be happiest on our tiles, and our tiles are at their best whenever floors are wet and feet are bare. Our most popular applications include: splash pads, slide pads, edge pads, slide towers, pools decks, and zero-depth entries. See some of our past and recent projects on the following pages.

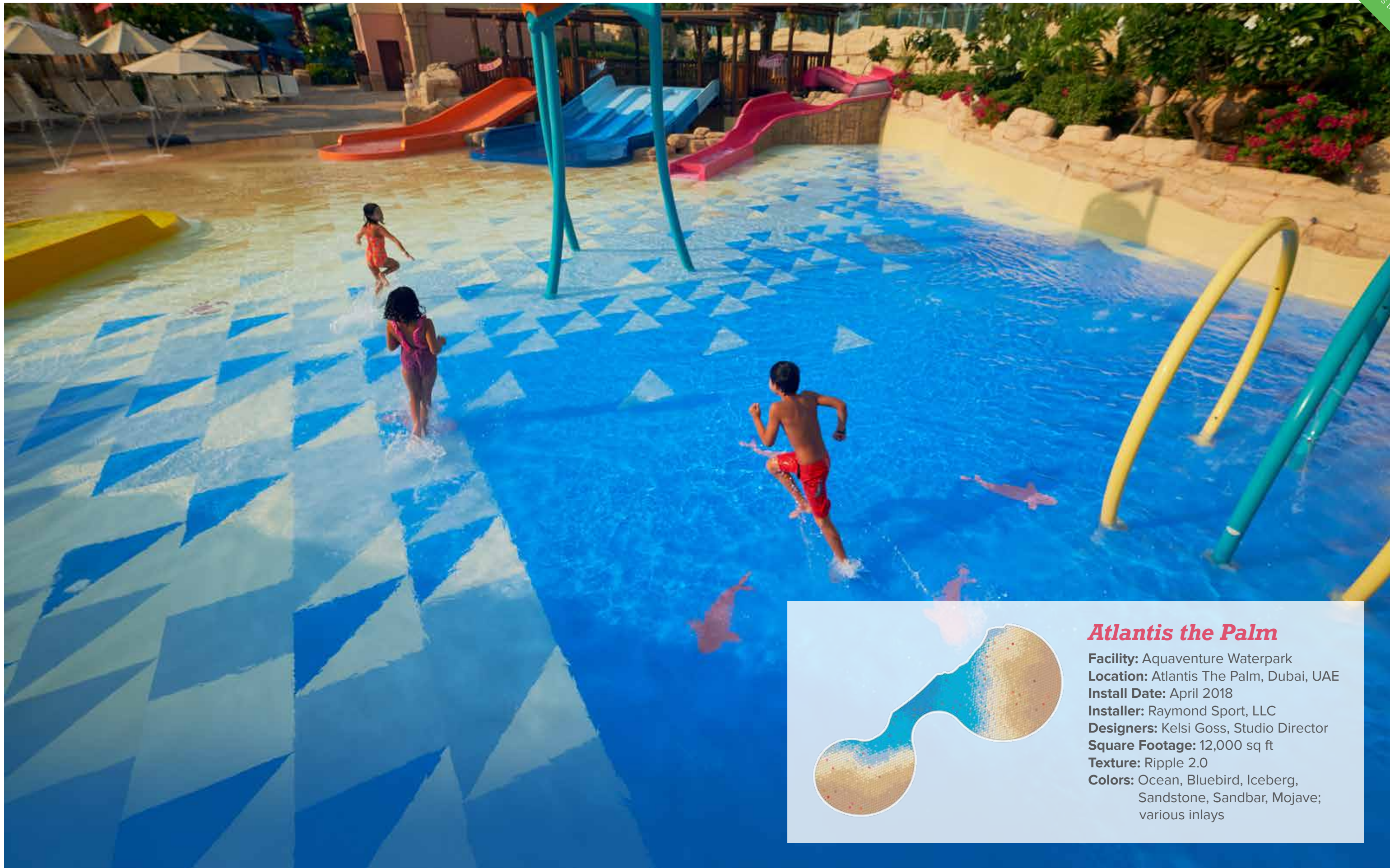

Atlantis the Palm

Facility: Aquaventure Waterpark
Location: Atlantis The Palm, Dubai, UAE
Install Date: April 2018
Installer: Raymond Sport, LLC
Designers: Kelsi Goss, Studio Director
Square Footage: 12,000 sq ft
Texture: Ripple 2.0
Colors: Ocean, Bluebird, Iceberg, Sandstone, Sandbar, Mojave; various inlays



“ The Atlantis project provided us with a great opportunity to create a large gradient effect given its size. Adhering to the theme, we created a design that resembled the beach using a combination of squares, triangles, and custom design inlays. We used the depth of the water in this kids play area to determine where to place the “sand” and the “water” in the design.

Kelsi Goss
Studio Director ”



Splash Pads

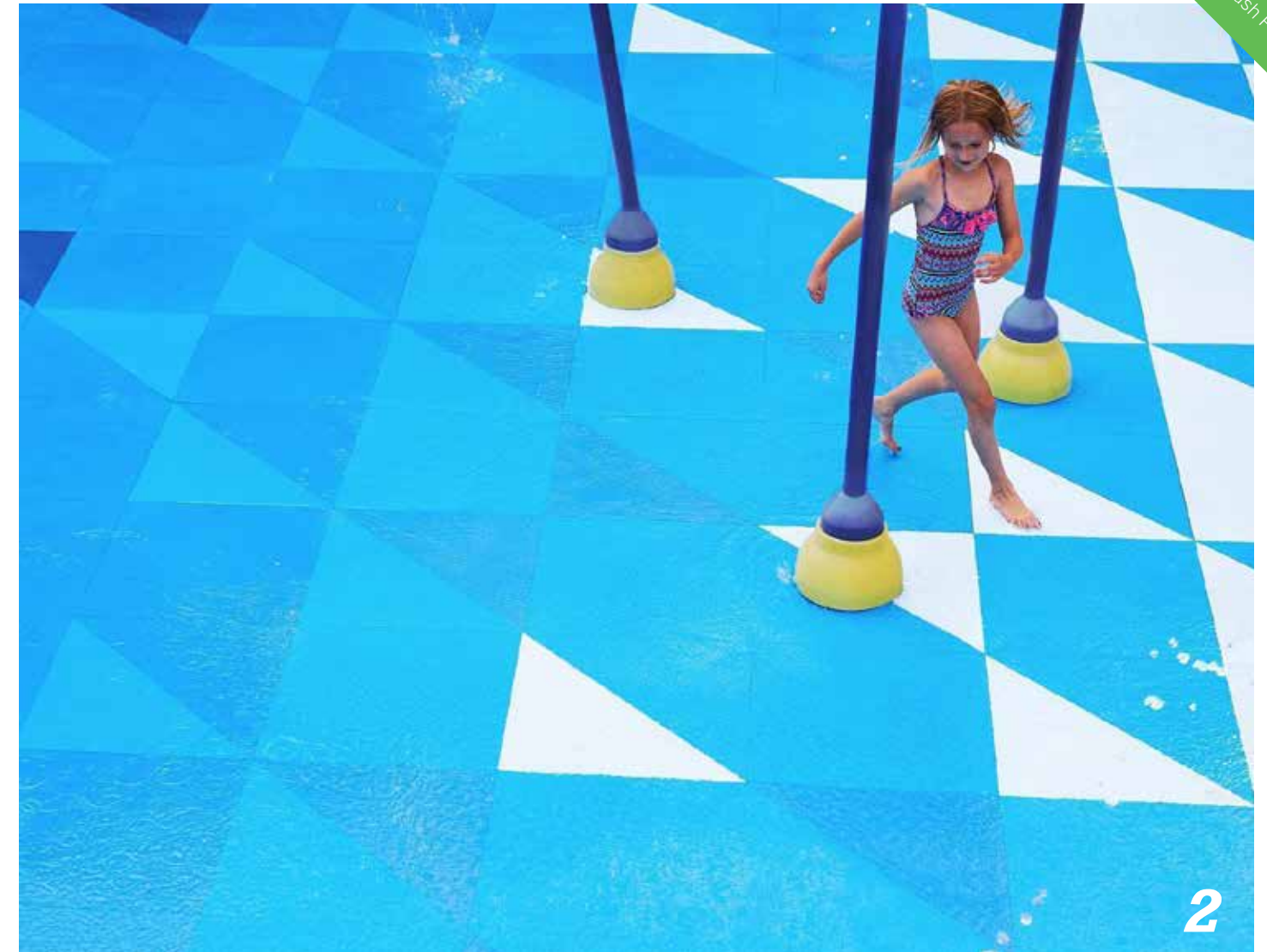

1. Parr Park, Grapevine, Texas, October 2019 (Bluebird, Turquoise, Limelight, Kestrel, Heron Ripple) 2. Cedarcrest Splash Pad, Bloomington, MN, June 2017 (Ocean, Bluebird, Aviator, Porcelain Ripple) 3. The Beach, JBR, Dubai, UAE, March 2018 (Ocean, Bluebird, Iceberg, Sandstone, Sandbar, Mojave, and Various Ripple Inlays) 4. Windsor Hills Resort, Orlando, Florida, March 2018 (Ocean, Iceberg, and Aviator Ripple)

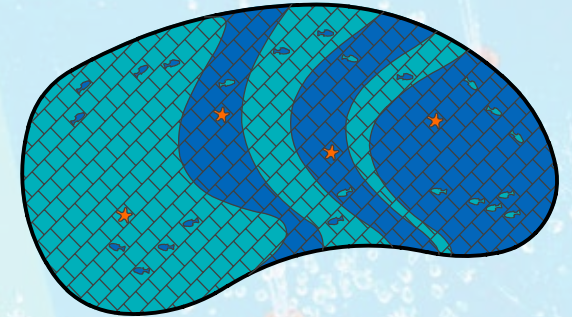
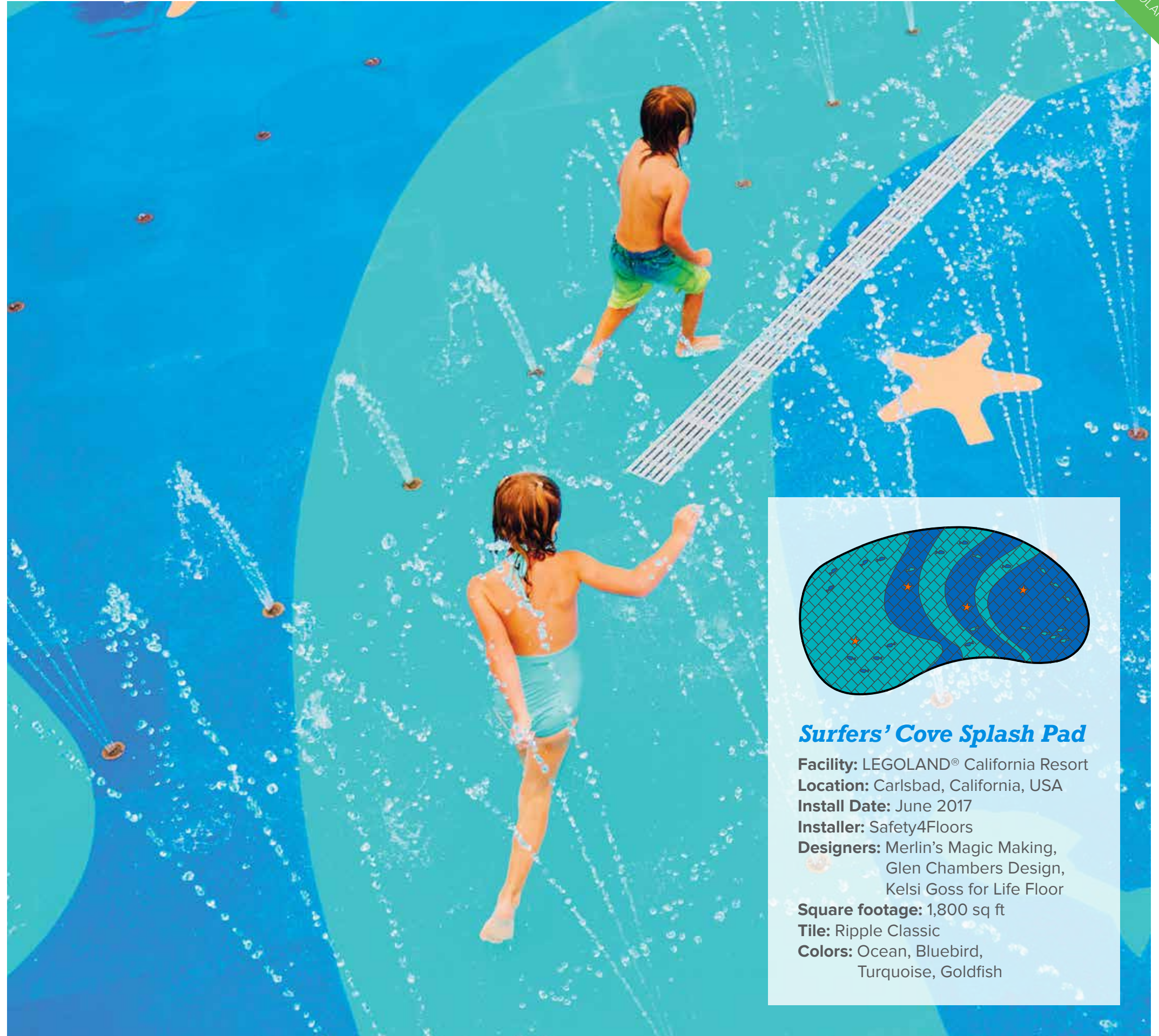

Surfers' Cove Splash Pad

Facility: LEGOLAND® California Resort

Location: Carlsbad, California, USA

Install Date: June 2017

Installer: Safety4Floors

Designers: Merlin's Magic Making,
Glen Chambers Design,
Kelsi Goss for Life Floor

Square footage: 1,800 sq ft

Tile: Ripple Classic

Colors: Ocean, Bluebird,
Turquoise, Goldfish

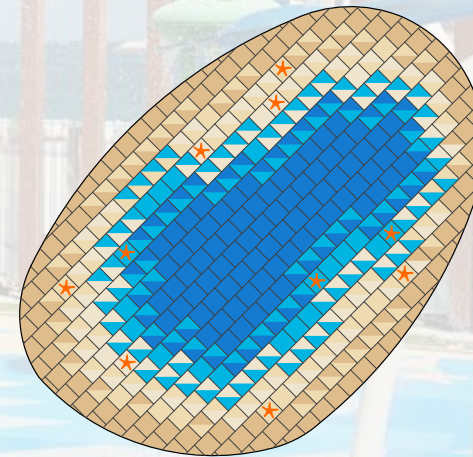

Splash Pad At The Beach

Facility: The Beach
Location: JBR, Dubai, UAE
Install Date: March 2018
Installer: Raymond Sport
Designers: Kelsi Goss,
Studio Director
Square footage: 4,200 sq ft
Tile: Ripple 2.0
Colors: Ocean, Bluebird, Iceberg,
Sandstone, Sandbar,
Mojave; various inlays





Indoor Pool Decks **The Grove Cove**

Life Floor's relationship with Maple Grove, Minnesota runs deep. One of our company's earliest customers, they were among the first to adopt a prototype of the product in their community's aquatic center. In 2017, they approached Life Floor about upgrading their old floor with a new deck, one that took advantage of everything we've learned about safety and design since our founding. The result is a Life Floor installation that ranks among our favorites anywhere. Utilizing Ripple 2.0, a multi-colored design approach, and fun, inlaid maple leaves, Maple Grove is the perfect example of how simple, effective design choices can elevate any public aquatic space to a truly world-class facility.

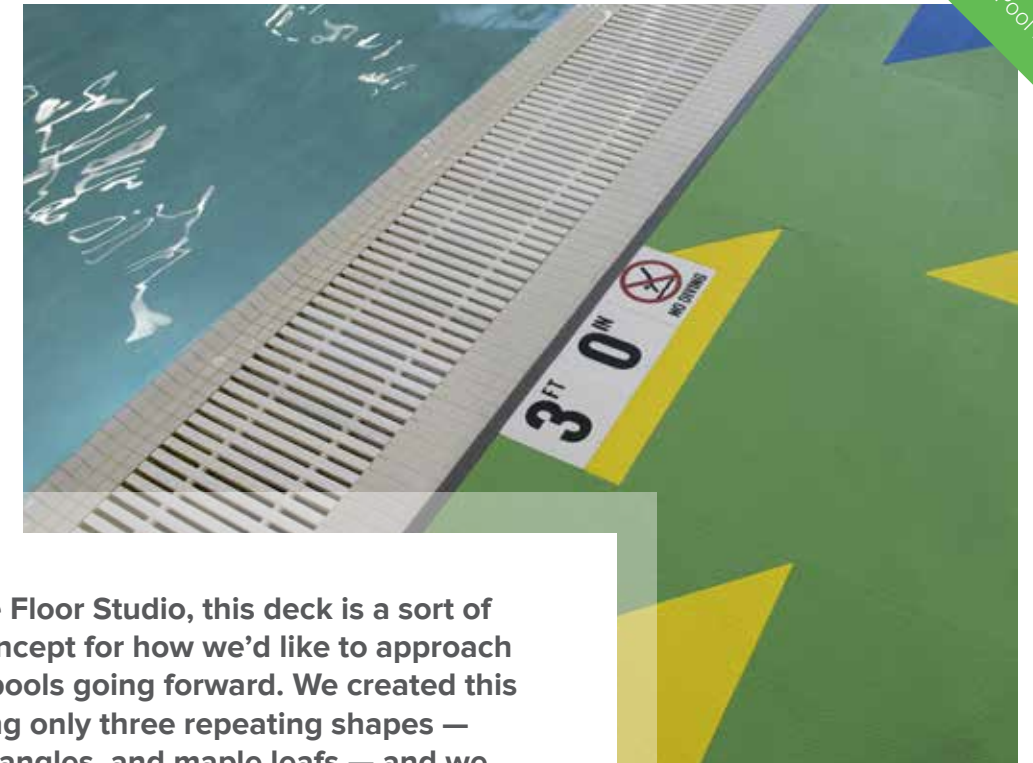

“ For the Life Floor Studio, this deck is a sort of proof of concept for how we’d like to approach municipal pools going forward. We created this design using only three repeating shapes — squares, triangles, and maple leaves — and we did it within a sensible budget. Frankly, this is my favorite interior pool deck we’ve ever done.

Sean Rubin
Life Floor Chief Creative Officer ”

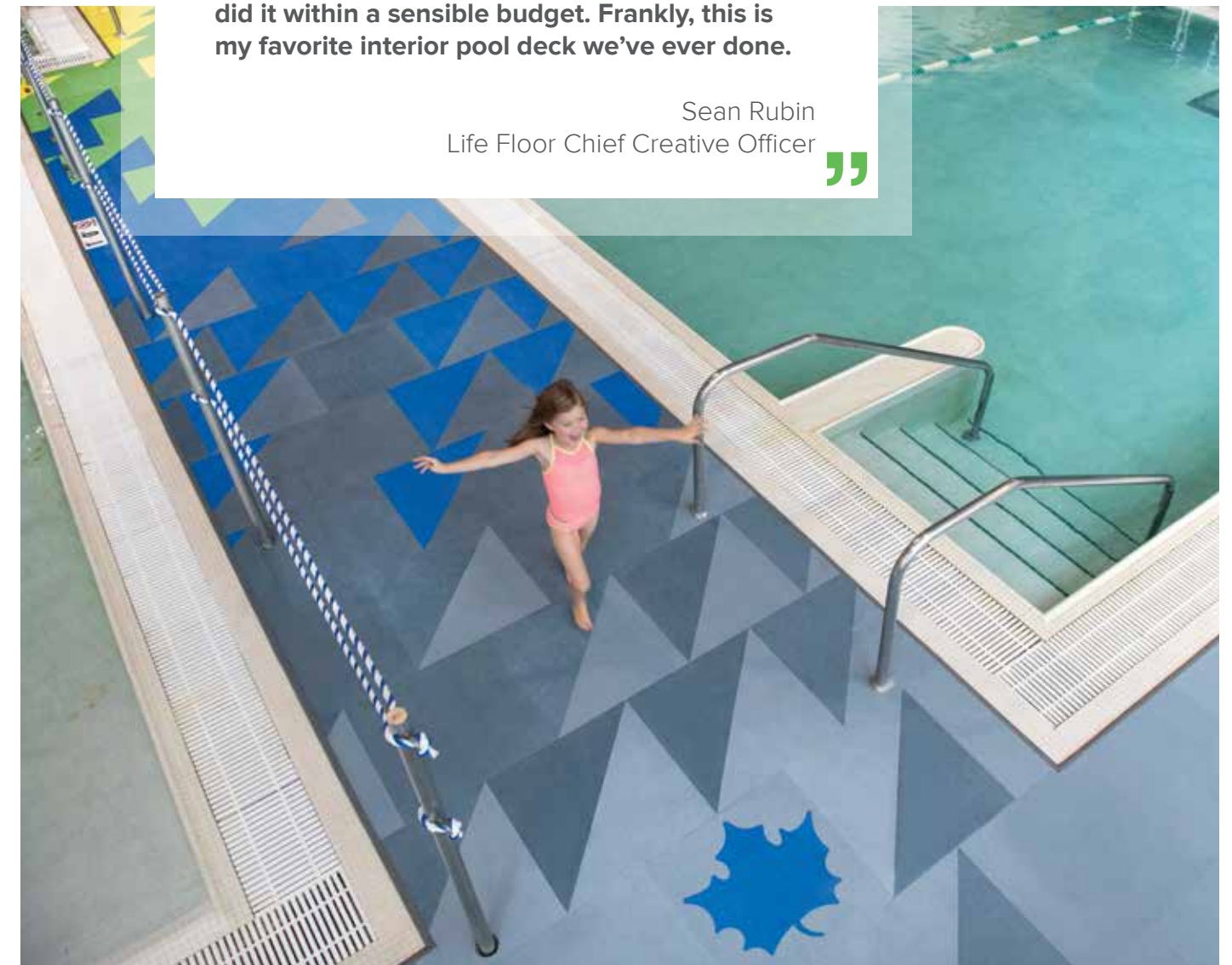



Indoor Pool Decks Bamboo Bay Waterpark

Keeping kids active and entertained in the winter is no short order, but with the brand new BAMBOO BAY at the Indoor Tropics Waterpark, kids and parents have their own personal get-away.

The City of Shoreview wanted BAMBOO BAY to be a new kind of indoor tropical space: a true kid's get-away. BAMBOO BAY was designed with huge windows to catch as much natural light as possible. While space for the build-out was limited, they filled the 7,000 sq ft space with over 40 play features for all levels of water comfort.

To maximize the enjoyment of younger kids, and eliminate the problems they'd been working

around for years with their concrete overlay pool deck, The Indoor Tropics Waterpark chose Life Floor in superbly comfortable 3/8" Slate for the majority of the deck in Tiki, Mojave, and Sepia to add warmth and tie in with the tropical theme. For additional safety, the edge of the pool had a contrasting color, Kestrel, installed in Ripple 2.0 for a visual and physical reminder of where the water started.

From day one kids have run freely on the surface without slipping or falling, allowing them to build confidence in and around the water, and parents to feel comfortable letting kids explore in the space.



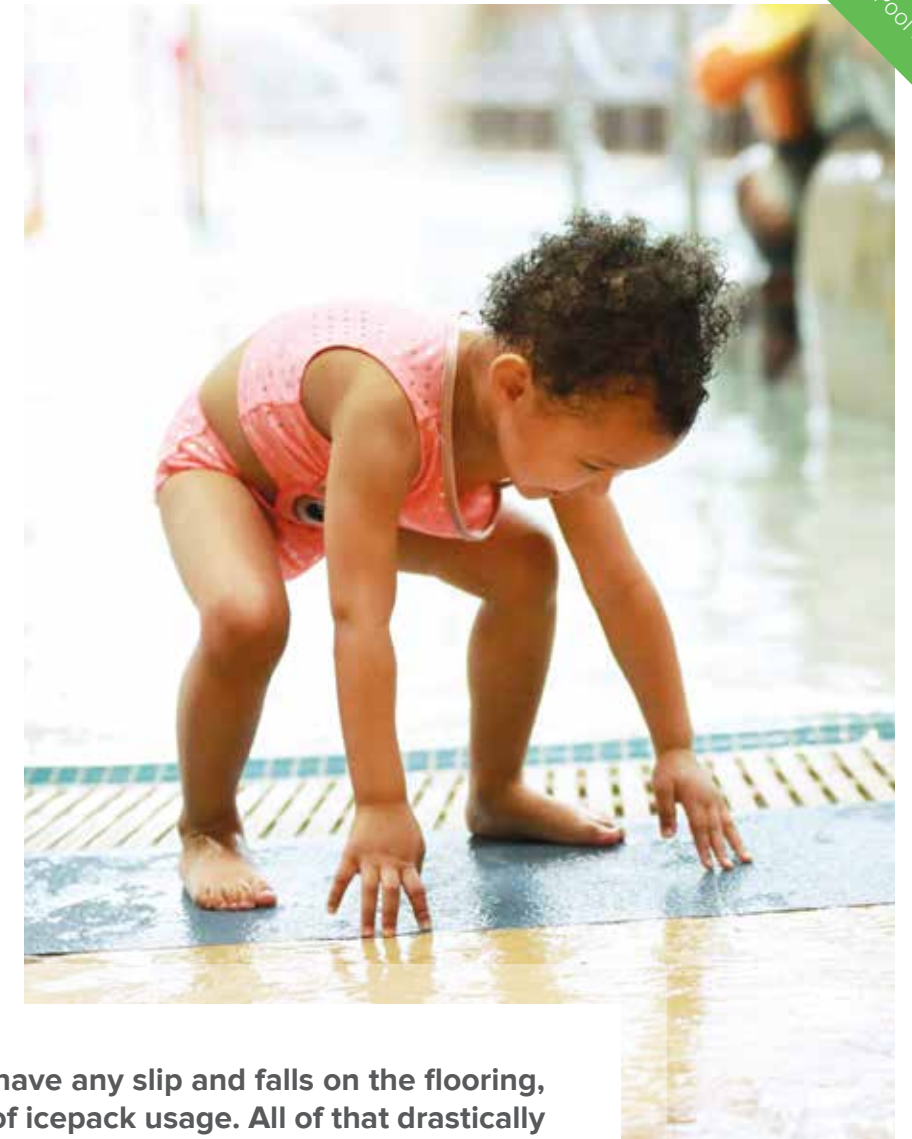

“ We hardly have any slip and falls on the flooring, or reports of icepack usage. All of that drastically went down. It’s been really great for us, everyone here from the guests to the desk staff has been singing their praises of the floor. ”

Diana Buck
Aquatic Supervisor of the Bamboo Bay Waterpark

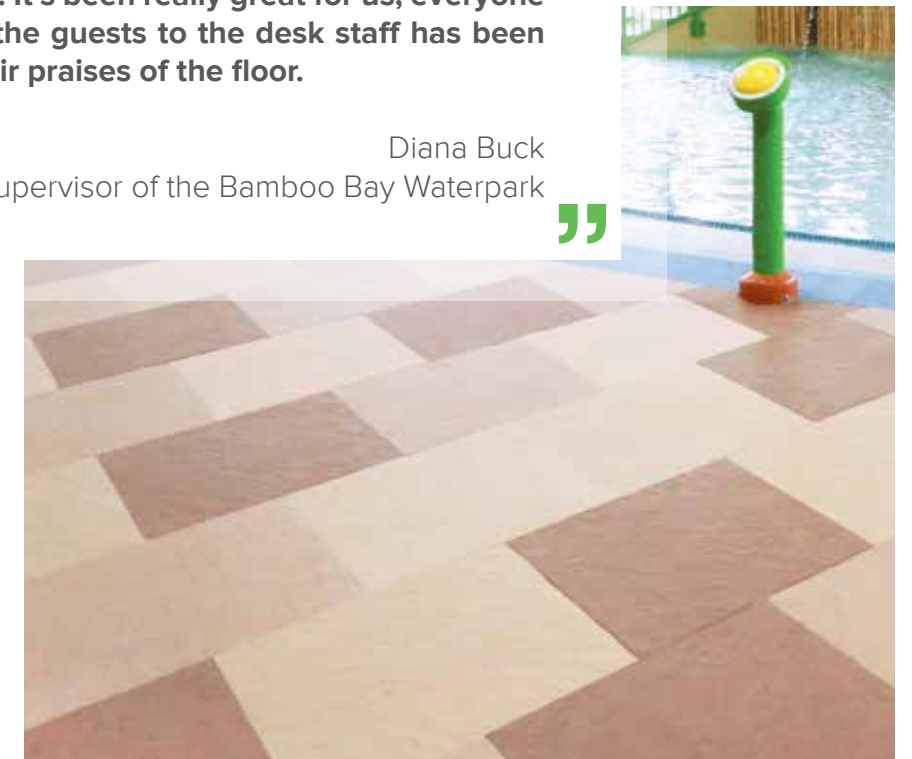

Outdoor Pool Decks

All Photos: Dolphin Bay Resort & Spa, Pismo Beach, California, May 2015 (Mojave, Sepia Slate)



Under Multi-Level Structures



1 and 2. Yogi Bear's Water Zone, North Java, New York, September 2017 (Ocean, Bluebird, Aviator Ripple)
3. Sugarland, Cairns, Queensland, Australia, August 2019 (Ocean, Bluebird, Aviator Ripple)



Under Multi-Level Structures Continued

All Photos: Costa Bavaro, Punta Cana, October 2019 (Ocean, Bluebird, Aviator, Porcelain, Sandstone, Sandbar, Mojave, Sunshine Ripple)



On Multi-Level Structures



1 and 2. Joker Soaker, LEGOLAND®, Winter Haven, FL, April 2015 (Bluebird Ripple)
3. Kings Dominion, Doswell, VA, July 2013 (Bluebird Ripple)



Zero-Depth Entries

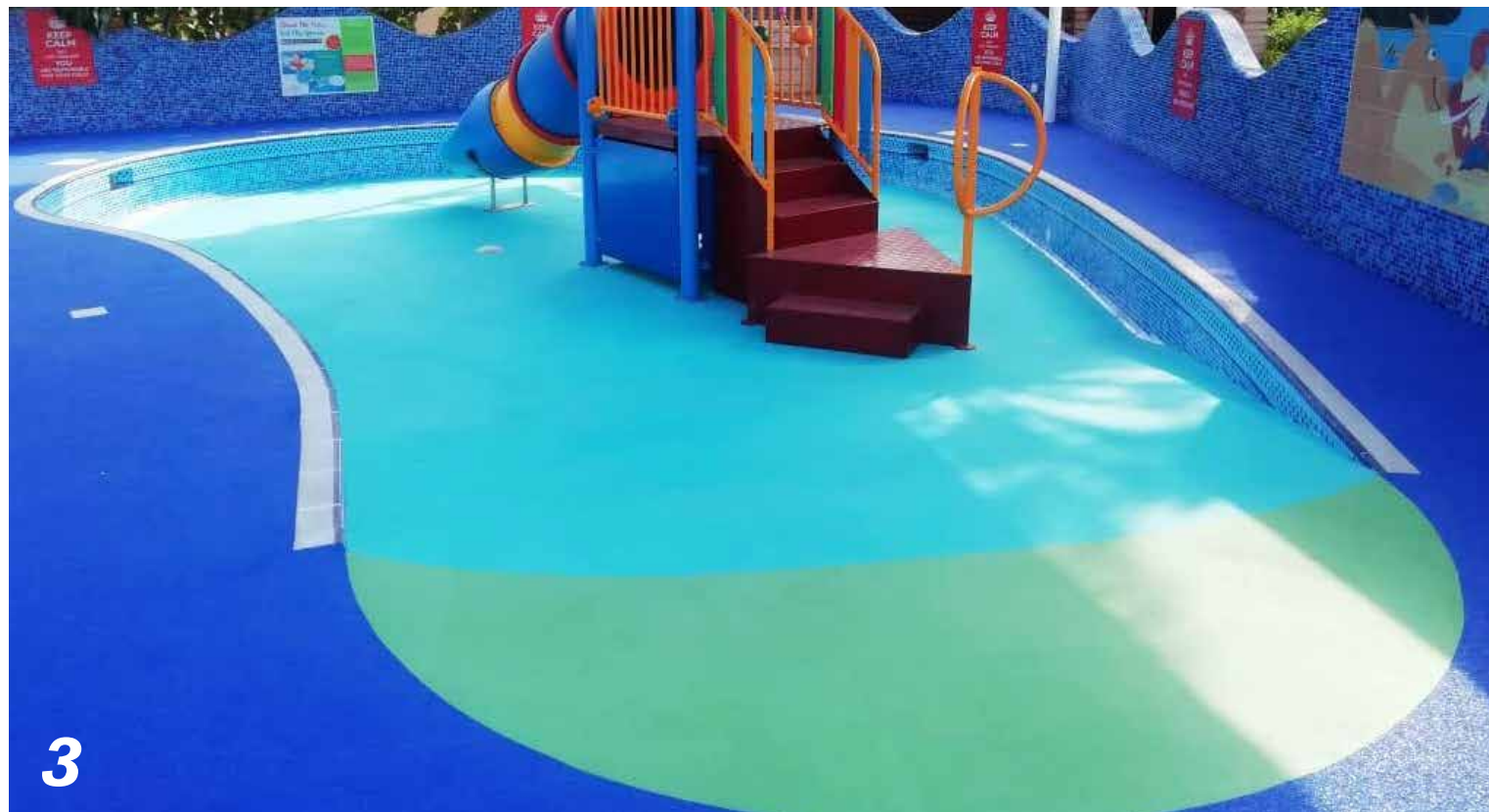

1 and 2. Habio Waterpark, Seoul, South Korea, October 2016 (Bluebird Ripple)
3. The Club, Abu Dhabi, UAE, August 2019 (Turquoise, Lilypad Ripple)
4. Massanutten Resort, McGaheysville, VA, October 2013 (Bluebird Ripple)

Edge Pads



1. Great Wolf Lodge Concord, Concord, North Carolina, September 2015 (Bluebird Ripple)
2. Noah's Ark, Wisconsin Dells, Wisconsin, May 2014 (Bluebird Ripple)
3. Great Wolf Lodge Grapevine, Grapevine, Texas, September 2018 (Pomegranate Ripple with Gobi Inlays)



Slide Towers

Photo: River Rock Rustic Board, Custom Texture: Rustic Board

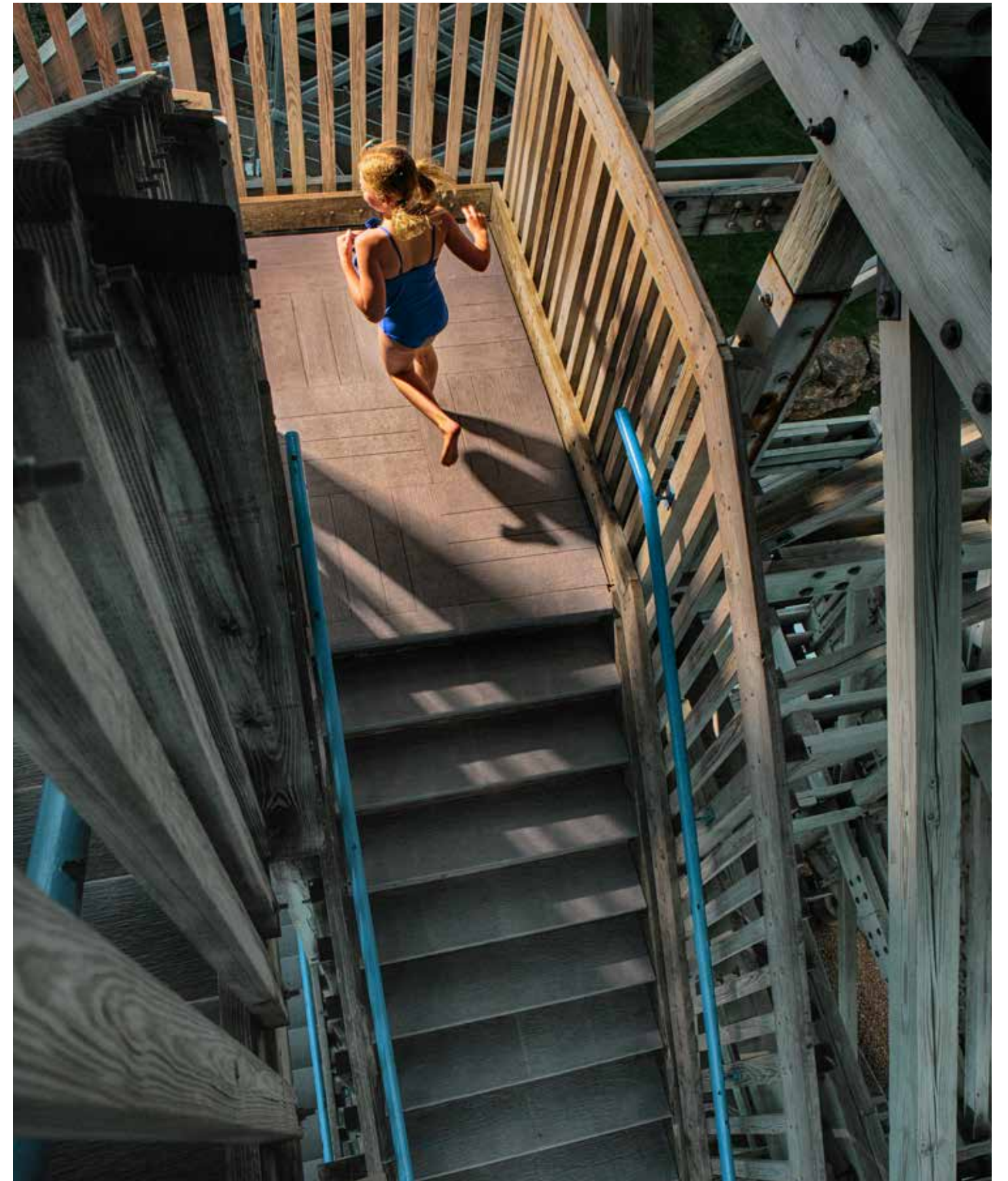

Cruise Ship Water Parks

All Photos: Carnival Imagination, September 2016 (Bluebird Ripple)

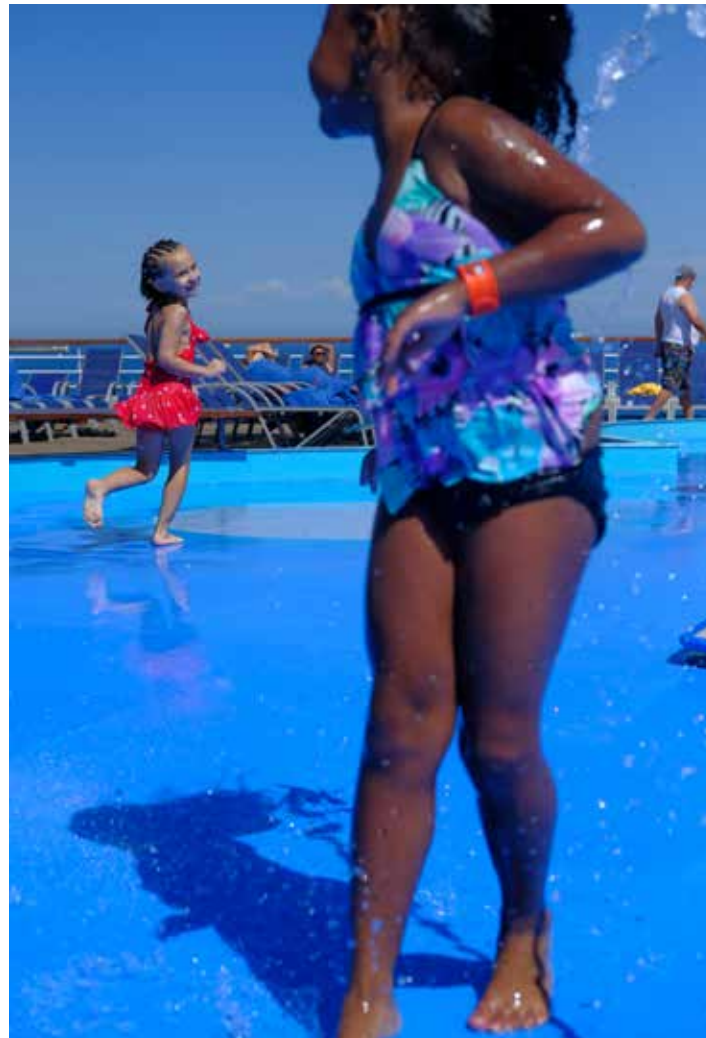
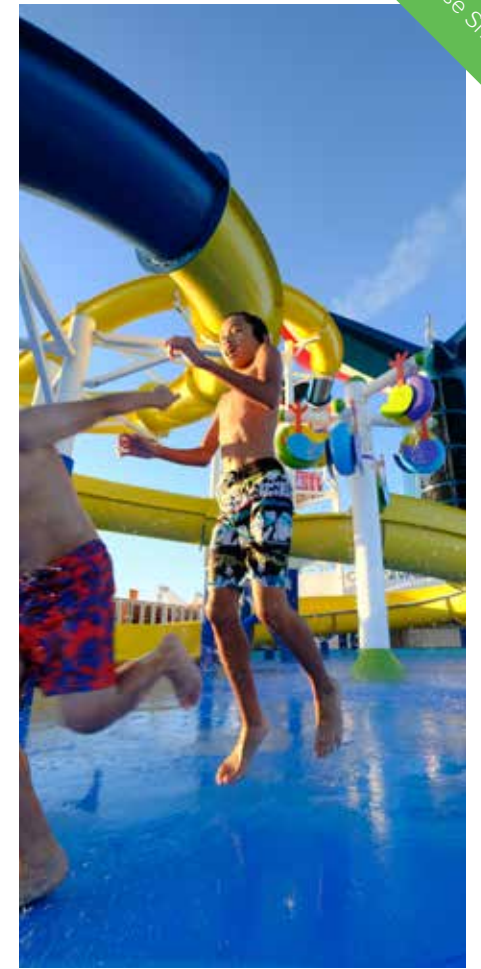

Announcing a new partnership with



Proper installation is essential to delivering our full surfacing solution and we've selected world-class installation experts to do just that. Earlier this year, we announced our partnership with North America's leading commercial flooring installation experts Inside Edge (iecis.com).

"What especially excites us about this partnership is the high level of detail in their proven processes to ensure projects are quoted accurately, installed on time and on budget, and ultimately completed to the absolute satisfaction of the customer. Our customers will experience the same level of service and benefits that the leading commercial brands do," said Jonathan Keller, Life Floor CEO.

Inside Edge Safety Surfaces provides an all-inclusive installation service for Life Floor customers with premier warranty coverage. Through this inaugural year, Inside Edge and Life Floor have won the appreciation of owners and operators countrywide. By working together, we have been able to provide customers with new innovative shapes and intricate designs. Our satisfied customers are thrilled with their installation experience:

"Your installers are great, I watched the process and everything they did was good and quick! They were diligent about it, they touched up seams, they did all the chalking, they made sure all the tiles were pressed down. If they weren't completely happy with how a tile was placed they would take the tile up and put down a new one to make sure it was good. They were so professional."

Heather Re of Westfield, NJ

Technical Data

Extensive testing has been performed on Life Floor tile, including slip resistance, flame and smoke spread, water and chemical resistance, UV and Ozone stability, temperature stability, and mold resistance.

Download full testing reports and SDS online at lifefloor.com/tech-documents.

Traction/Slip-resistance

ASTM 303-93(2008) BPN Value when wet: Ripple 55-58; Ripple Classic 42-45; Slate 40-42.



Certified to NSF/ANSI Standard 50

Ripple 2.0 in 3/8" is certified to the NSF/ANSI 50 standard for interactive water play venues.

Visit lifefloor.com/nsf50

Cushioning/Impact Attenuation

ASTM F 1292-10; Standard Specification for Impact Attenuation of Surface Systems Under and Around Play Equipment: 3/8" tile: 1'-0", 7/8" tile: 4'-0".

Water Permeability

ASTM F 1551-09: Standard Test Methods for Comprehensive Characterization of Synthetic Turf Playing Surfaces and Materials: Suffix-DIN 18-035, Part 6: Water Permeability of Synthetic Turf Systems and Permeable Bases: Products will not allow vertical drainage.

Flammability

ASTM E648-03 Critical Radiant Flux Class 1 interior floor finish rating ASTM E84-04 Flame Spread Index 255, Smoke Development Index 300IMO Certified for interior and exterior finishes

Physical Properties

UV Stable, does not support the growth of microbes, closed cell, chemical resistant

©2020 MNY Group, LLC

Life Floor is a Registered Trademark of MNY Group, LLC. All Rights Reserved.

Life Floor is made in the USA in South Dakota.

2010 East Hennepin Ave #8 Building 8, Suite 206 Minneapolis, Minnesota 55413

612.567.2813 solutions@lifefloor.com

Photography by Edward Addeo, Jennifer Ceci, Briana Massie, and Garrett Reid.

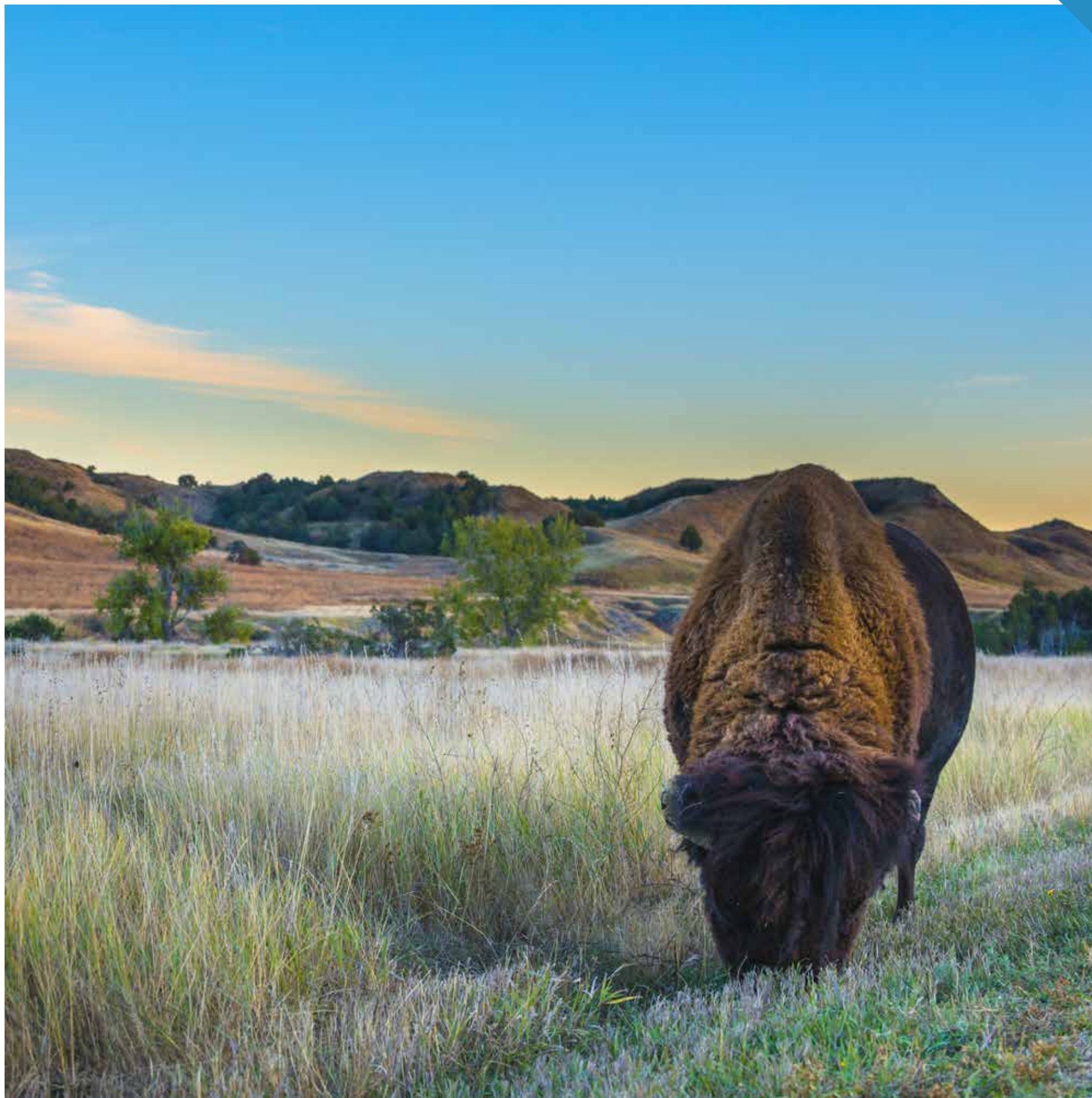



LIFE FLOOR™

Life Floor® is a registered trademark of MNY Group, LLC.
©2020 MNY Group, LLC. All rights reserved.

LIFE
FLOOR